

FineSANI

Quick Start Guide

1. Installation – Launching
2. Calculation Environment
3. CAD Component

Preface

This Quick Start Guide provides a fast and friendly introduction on FineSANI main features and functionalities. All the features and functions of the program are presented and explained in detail within the complete User's Guide, along with informative examples.

FineSANI, the **F**ully **I**ntegrated **E**nvironment for **Water Supply** and **Sewage** Installations combines both designing and calculations in a uniform, integrated environment, consisting of two main components, CAD and Calculations:

- Concerning the **CAD component**, it is based on an autonomous CAD embedding 4MCAD engine adopting the common cad functionality and open .dwg drawing file format. The CAD component helps the user to design and then calculate and produce completely automatically the entire calculations issue for every Sanitary project, as well as all the drawings in their final form.
- Concerning the **Calculations component** (called also as ADAPT/FCALC), it has been designed according to the latest technological standards and stands out for its unique user - friendliness, its methodological thoroughness of calculations and its in-depth presentation of the results. The SANI Calculation Environment consists of 2 modules, the **Water Supply System module** and the **Sewage system module**. Each module acquires data directly from the drawings (automatically), thus resulting in significant time saving and maximum reliability of the project results. It can also be used independently, by typing data within the module spreadsheets.

Despite its numerous capabilities, FineSANI has been designed in order to be easy to learn. Indeed, the simplicity in the operation philosophy is realised very soon and all that the user has to do is to familiarise with the package.

This Guide is divided into 3 short parts:

- Part 1 describes the installation procedure and the main menu structure.
- Part 2 deals with the CAD component of FineSANI, showing its philosophy and main features.
- Part 3 describes the calculation environment of FineSANI, composed of the Water Supply and Sewage application modules.

FineSANI	<i>i</i>
Preface	<i>iii</i>
1. Installation - Launching	1
1.1 Installing FineSANI	1
2. CAD Component	3
2.1 Overview	3
2.2 Main menu	3
2.3 Drawing Principles & Basic Commands	5
2.3.1 Drawing aids	6
2.3.2 Drawing Coordinates	6
2.3.3 Drawing Basic Entities	7
2.3.4 Useful Commands	7
2.3.5 Grips	8
2.3.6 Print	9
2.3.7 Plus Drawing Tools	9
2.4 AutoBUILD: Architectural Drawing	10
2.4.1 Building Definition	11
2.4.2 Drawing Walls	12
2.4.3 Drawing Openings	13
2.4.4 Other Entities	13
2.5 AutoNET: Network Drawing Principles	14
2.6 AutoNET: FineSANI Installations	21
2.6.1 Water Supply System	21
2.6.2 Sewage	27
3. Calculations	33
3.1 Overview	33
3.2 Water Supply	37
3.2.1 Files	37
3.2.2 Project Data	38
3.2.3 Import data from the Vertical Diagram	39
3.2.3.1 <i>Vertical Diagram Creation</i>	40
3.2.3.2 <i>Update from vertical diagram</i>	43
3.2.4 View	43
3.2.5 Windows	43
3.2.5.1 <i>Cover Page</i>	43
3.2.5.2 <i>Assumptions</i>	44
3.2.5.3 <i>System of appliances</i>	44
3.2.5.4 <i>Hydraulic Receptors Legend</i>	44
3.2.5.5 <i>Calculation Sheet</i>	44
3.2.5.6 <i>Pressure Vessel</i>	49
3.2.5.7 <i>Pressure Vessel with membrane</i>	49
3.2.5.8 <i>Network Drawing</i>	49
3.2.5.9 <i>Vertical Diagram</i>	49
3.2.5.10 <i>Sections friction drop</i>	49
3.2.5.11 <i>Bill of Materials - Costing</i>	49
3.2.5.12 <i>Detailed bill of materials</i>	49
3.2.5.13 <i>Technical Description</i>	50
3.2.6 Libraries	50

3.2.7 Help	50
3.3 Sewage	51
3.3.1 Files	51
3.3.2 Project data	51
3.3.3 Import data from the Vertical Diagram	53
3.3.3.1 <i>Vertical Diagram Creation</i>	53
3.3.3.2 <i>Update from a vertical diagram</i>	55
3.3.4 View	55
3.3.5 Windows	55
3.3.5.1 <i>Cover Page</i>	56
3.3.5.2 <i>Assumptions</i>	56
3.3.5.3 <i>System of appliances</i>	56
3.3.5.4 <i>Label of appliances</i>	56
3.3.5.5 <i>Calculation Sheet</i>	56
3.3.5.6 <i>Septic tank calculation</i>	61
3.3.5.7 <i>Pit calculation</i>	61
3.3.5.8 <i>Sewage lift station calculation</i>	61
3.3.5.9 <i>Sewage lift pump calculation</i>	62
3.3.5.10 <i>Network drawing</i>	62
3.3.5.11 <i>Vertical Diagram</i>	62
3.3.5.12 <i>Bill of Materials - Costing</i>	62
3.3.5.13 <i>Technical Description</i>	62
3.3.5.14 <i>Detailed bill of materials</i>	62
3.3.6 Libraries	62
3.3.7 Help	62

1. Installation - Launching

1.1 Installing FineSANI

1. Insert the CD in your computer CD-ROM drive (e.g. D:, E:) or, if you received your software via Internet, run the installation application you downloaded.
2. When the Welcome page appears (as shown below), click **Next**.

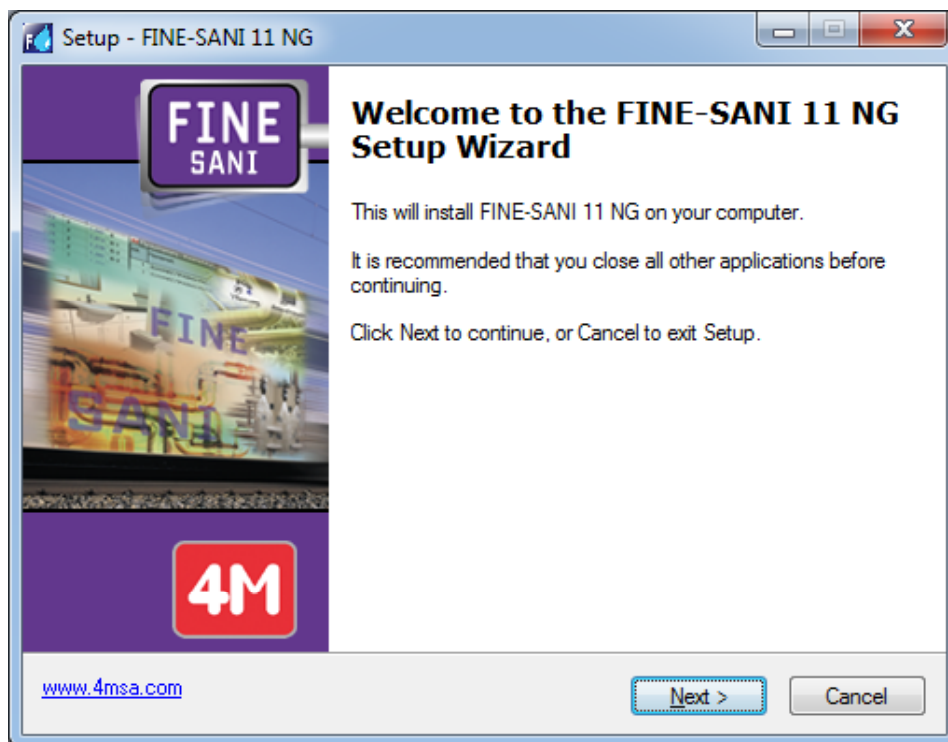

3. When the License Agreement appears, read it carefully. If you agree with the terms, check the respective "radio button" and then click **Next** (you must agree with the terms to proceed with the installation).
4. In the next screen enter your username and organization information and check if you want to create a desktop icon. Then click **Next** to see if the information is correct (see the following window) and finally click **Install** for the installation procedure to begin.
5. Upon completion of the installation procedure, the following last window appears on screen and all needed is to click **Finish**. In case that the **Run FineSANI** checkbox is selected, the program will start running.



6. After installation, the program is located within the programs list.

2. CAD Component

2.1 Overview

FineSANI is a powerful Workstation of Water Supply and Sewage Projects, which automatically performs the necessary hydraulic calculations directly from the drawings, producing all the Project results (Calculation issue, technical descriptions, full-scale drawings, Bills of materials etc). FineSANI automates the designing processes providing the user with the appropriate installation designing solutions.

This first Part (Part I) of the user's guide describe the operation of the CAD component of FineSANI. As mentioned in the preface, the CAD component is based on 4MCAD technology, including 4MCAD.

Regarding technical aspects, it should be mentioned that the package follows a completely object oriented philosophy (OOP). This practically means that the package considers the building and the SANI installations as logical entities which consist of individual objects clearly related to each other and with accurately defined characteristics. These intelligently structured "information" of the building and its sanitary installations combined with the advanced technology (C++) that was utilised for its development, provide the package with an experienced behaviour, resulting in an Intelligent Workstation, that is an invaluable helping hand to every Designer.

FineSANI CAD Component includes 2 main modules, which co-operate closely and give the Designer the impression he virtually works on the building: It is about a) the AutoBUILD (or AutoBLD) that is used to load-identify the building and b) the AutoNET that is used to design and identify the network installations. Those two subsystems are supported by a third one, with the name PLUS, which includes many useful designing facilities.

2.2 Main menu

As soon as the program is loaded, the main menu screen appears for the first time:

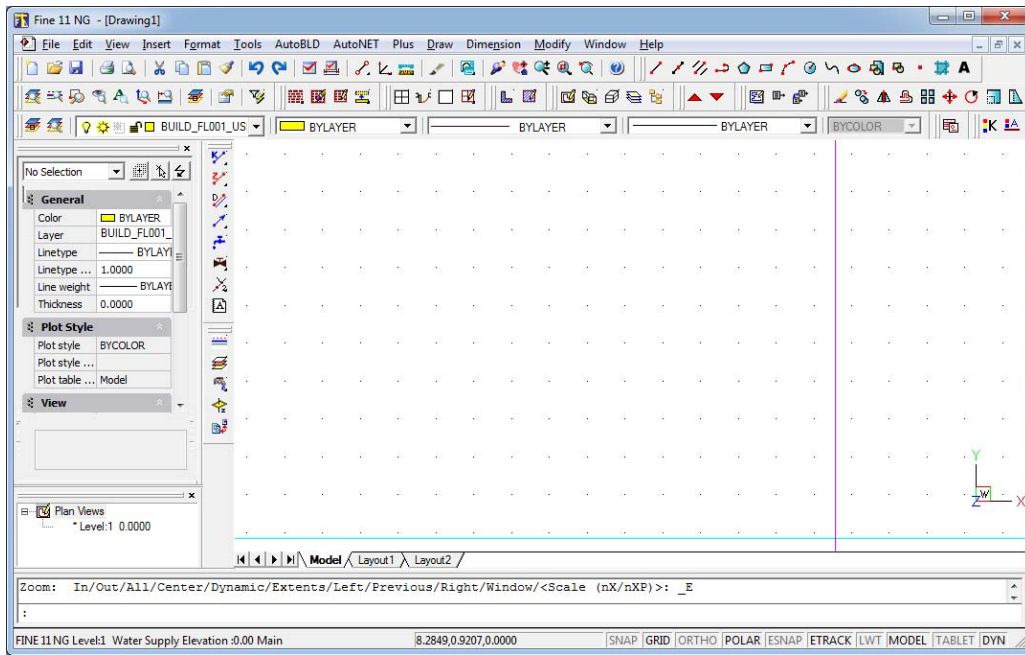

Among the commands of the designing environment, we notice the following main options of the package:

1. Project files management options (New Project, Open Project and Project Information) which are located into the options group FILE.
2. Option Group with the name **AutoBLD**, which includes all the commands required for the Architectural designing.
3. Option group with the name **AutoNET**, which includes all the commands required for the designing and calculation part of the applications (Single-pipe system, Twin-pipe System, Electrical Wiring etc).
4. Auxiliary option group with the name **PLUS**, which contains many designing facilities for the user.

To create a project with FINE, a new project should be defined by using the corresponding command FILE -> "NEW PROJECT". When this command is selected, a window appears on the screen where the name of the Project should be typed.

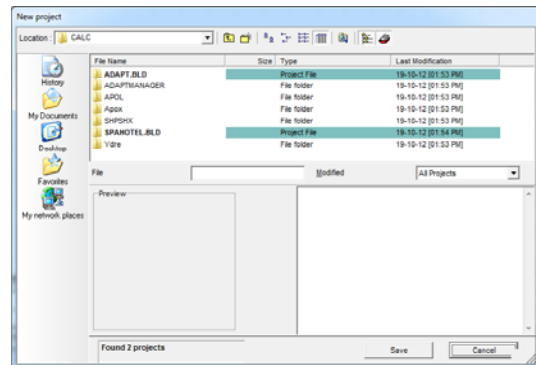

In order to "open" an existing project, that is a project which has been created with the program and you want to edit it or just view it, then you should select the command "Select Project", and a list with the existing projects in the hard drive will be displayed on the screen. At first, the list displays all the projects that exist in the FINE directory, but you can be transferred to any other directory, viewing at the same time the existing projects. It is noted that the projects are included into directories with the extension BLD. If an existing project is selected, it is loaded and displayed on the screen.

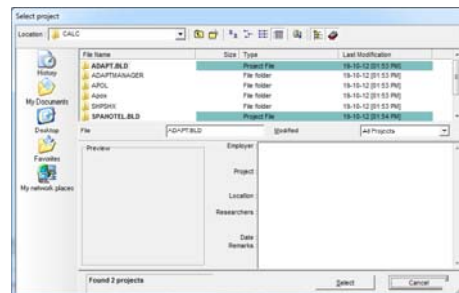

A short reference of the basic designing principles in the designing environment of the package is recommended, in chapter 2 that follows next. If you are familiar with the use of Autocad or 4MCAD, you may skip chapter 2, while if you are not you should read it carefully.

2.3 Drawing Principles & Basic Commands

A great advantage of the package is that the structure and the features of the drawing environment follow the standards of the CAD industry adopted by AutoCAD, 4MCAD etc. In particular, the available working space is as follows:

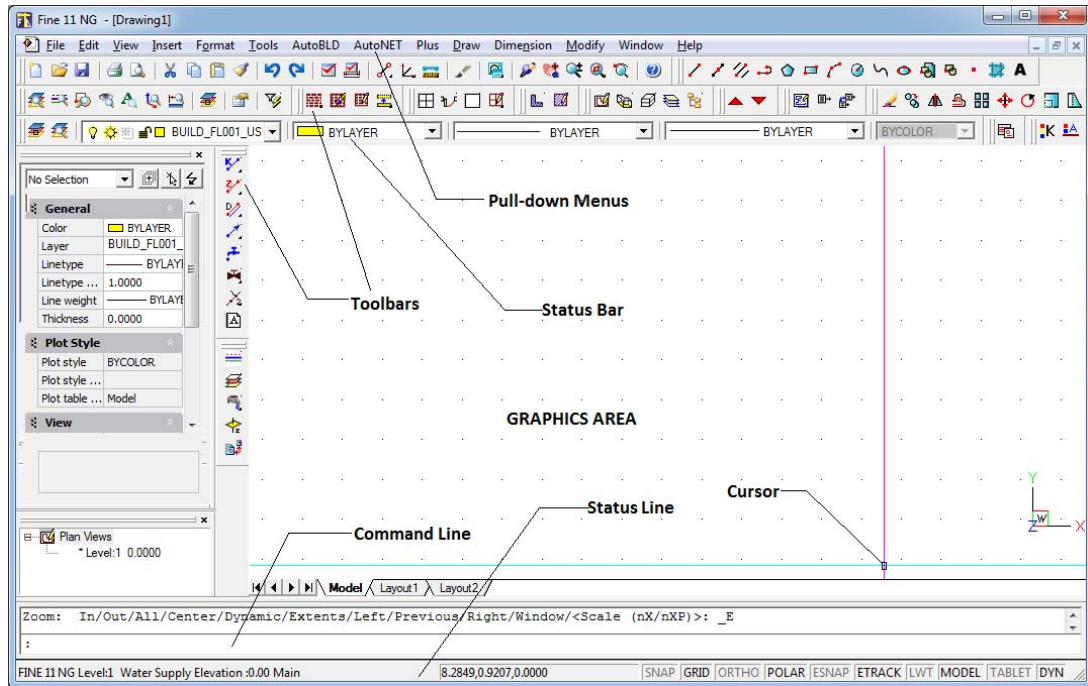

As shown in the above figure, the screen is divided into the following "areas":

- **Command line:** The command line is the area where commands are entered and the command messages appear.
- **Graphics area:** The largest area of the screen, where drawings are created and edited.
- **Graphics cursor:** The cursor is used for drawing, selecting objects and running commands from the menus or the dialog boxes. Depending on the current command or action, the cursor may appear as a graphics cursor (crosshairs), a selection box, a graphics cursor with a selection box etc.
- **Pull-down menus:** These menus appear by selecting them with the .
- **Status Line:** It is the line on the bottom of the screen where the current level , the drawing status and the current cursor coordinates are displayed.

2.3.1 Drawing aids

This section describes the basic drawing aids available to the user. These are the commands **Osnap** (object snap), **Ortho** (vertical/horizontal drawing), **Grid** and **Snap** (movement increment). More specifically:

OSNAP: The "Osnap" command forces the cursor to select a snap point of an object, which is within the Pick box outline. The snap points are characteristic geometric points of an object (i.e. endpoint of a line). If you have specified a snap point and move the cursor close to it, the program will identify it with a frame. The "Osnap" command can be activated either by holding down the "SHIFT" key and right clicking the mouse or by clicking the middle mouse button or through the additional toolbar.

ORTHO: The "Ortho" feature restricts the cursor to horizontal or vertical movement. The status bar shows whether the "Ortho" command is activated by displaying "ORTHO" in black characters (in AutoCAD 12, the indication "O" also appears on the top left side of the screen). The command is activated or deactivated by clicking the corresponding button-icon or by pressing **F8**.

GRID: The screen grid is a pattern of vertical and horizontal dots, which are placed at the axes intersection points of an imaginary grid. The grid can be activated or deactivated by clicking the corresponding button-icon or by pressing **F7** (If the grid is active, it appears on the Status Bar).

SNAP: The graphics cursor position coordinates appear in the middle of the upper part of the graphics area. If "Snap" is selected, the graphics cursor movement may not be continuous but follow a specific increment (minimum movement distance). When "Snap" is on, the cursor seems to adhere, or "snap", to an invisible grid. "Snap" can be turned on and off either by clicking the corresponding button/icon or by pressing **F9**. (If it is activated, it appears on the Status Bar). The default Snap setting is **0.05 m** for both axes (X and Y).

2.3.2 Drawing Coordinates

When you need to determine a point, you can either use the mouse (by seeing the coordinates in the status bar or using the snap utilities), or enter the coordinates directly in the command line. Moreover, you can use either Cartesian or polar coordinates, either absolute or relative values, in each method (relative coordinates are usually more convenient).

Relative coordinates: Enter the @ symbol (which indicates relative coordinates) and then the x,y,z coordinates (Cartesian system) or the $r<\theta<\phi$ coordinates (polar system) in the command line. The system used (Cartesian or polar) is defined by the "," or "<" symbol. If you do not insert a value for z or ϕ , it will be automatically taken as zero. For example, if you are prompted to locate the second (right) endpoint of a 2m horizontal line, you should enter:

@2,0 if you use the Cartesian coordinates (which means that the distance of the second point from the first is 2 m on the x axis and 0 m on the y axis), or

@2<0 if you use the polar coordinates [which means that the second point is at a distance of 2m ($r=2$) and an angle of 0 degrees ($\theta=0$) from the first].

Absolute coordinates: These are specified like the relative coordinates, but without using the @ symbol. The absolute coordinates are specified in relation with the 0,0 point of the drawing.

The measurement system can be activated, deactivated or changed with the F6 key.

2.3.3 Drawing Basic Entities

Line: "Line" option is used for drawing segments. When you select "Line" from the menu or type "Line" in the command line, you will be prompted to specify a start point (by left clicking or by entering the point coordinates – relative or absolute – in the command line) and an endpoint (determined in the same way).

Arc: The "Arc" command is used for drawing arcs. An arc can be drawn in different ways: The default method is to specify three points of the arc ("3-Points"). Alternatively, you can specify the start point and endpoint of the arc as well as the center of the circle where it belongs (St, C, End). The user will not find it difficult to understand and become familiar with the various methods of drawing an arc.

Polyline: This command allows you to draw polylines, which are connected sequences of line or arc segments created as single objects. The command is executed by either using the menu or typing "pline" in the command line. You will be prompted to specify a start point and an endpoint (by right clicking the mouse or by entering the point coordinates – relative or absolute – in the command line). Then, the command options will appear (Arc, Close, Length etc). Select **A** to switch to Arc mode, **L** to return to Line mode and **C** to close the polyline.

2.3.4 Useful Commands

This section includes brief descriptions of the basic program commands, which will be very useful to the user. These are the commands "Zoom", "Pan", "Select", "Move", "Copy" and "Erase". In particular:

Zoom: "Zoom" increases or decreases the apparent size of the image displayed, allowing the user to have a "closer" or "further" view of the drawing. There are different zooming methods, the most functional of which is the real-time zooming ("lens / ±" button). You can use the mouse to zoom in real time – that is to zoom in and out by moving the cursor. There are a number of zoom options as shown by typing "Zoom" in the command line: All/Center/Dynamic/Extents/Left/Previous/Vmax/window/<Scale(X/XP)>

Pan: "Pan" ("hand" icon) moves the position of the visible part of the drawing, so that you can view a new (previously not visible) part. The visible part of the screen moves towards the desired area and to the desired extent.

Select: This command selects one or more objects (or the whole drawing), in order to execute a specific task (erase, copy etc.). Select is also used by other CAD commands (for example, if you use the "Erase" command, "Select" will be automatically activated in order to select the area that will be erased).

Move: This command allows moving of objects from one location to another. When the "Move" command is activated, the "Select" command is also activated so that the object(s) the user wants to move (in the way described in the previous paragraph) can be selected.

After you have selected the desired object(s), you are prompted to specify the base point (using the snap options), which is a fixed point of the drawing. When you are prompted to specify the position where the base point will be moved, use either the mouse or the snap options. After you have completed this procedure, the selected object(s) will move to the new position. Please note that the base and the new location points can be also specified with the use of coordinates (absolute or relative, see related paragraph).

Copy: The "Copy" option allows the copying of objects from one location to another. The "Copy" procedure is similar to the "Move" procedure and the only difference is that the copied object remains at its original location in the drawing.

Erase: Choose this option to delete objects. The procedure is simple: Select the objects you wish to erase (as described above), type "E" in the command line and press <Enter>. Alternatively, you may first type "E" in the command line, then select the object(s) by left clicking and finally right click to erase the object(s).

DDInsert (Insert Drawing): This command allows the user to insert another drawing (DWG file) or block in the drawing. When this command is selected, a window appears in which you should select block or file and then select the corresponding block or file from disk. Then you are prompted to specify the insertion point, the scale factor etc, so that the selected drawing is properly inserted.

Wblock: The "Wblock" command allows us to save part of a drawing or the entire drawing in a file, as a block. When this command is selected, you are prompted to enter the file name and then you should select the drawing or the part of the drawing you wish to save. The use of this command is similar to the "Screen Drawing" command, which will be described in a following section. In order to insert a block in a drawing, you should use the "ddinsert" command described above.

Explode: The "Explode" command converts a block in a number of lines so that you can edit it in that form. If it is selected, the program will prompt you to select the block ("Select object") you wish to explode.

2.3.5 Grips

Grips are some characteristic points of an object that appear while this object is selected (by moving the cursor on the object and left clicking). Then object is displayed with grips (small squares), which mark control locations and are powerful editing tools. When you click a grip, it turns red and the following prompt appears in the command line: ****STRETCH**** <stretch to point> /Base point /copy/ undo/ exit. If you press <Enter> (or right click), the first characters of the corresponding word are entered, e.g. "sc and enter" for the "Scale" command).

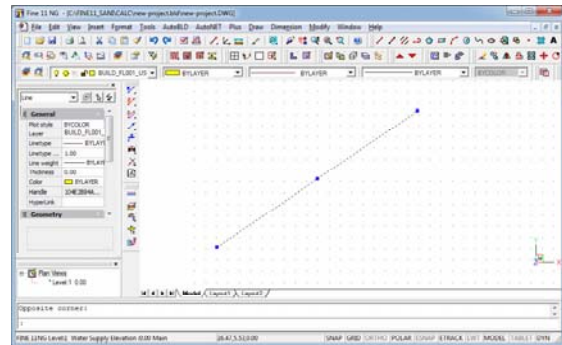

When a command is executed, grips disappear and the objects are unselected. If the command is an editing command (correction or copy), which can be preselected, the objects take part in the execution of the command automatically. In this case, the command overrides the "Select objects" prompt and proceeds. To unselect grips and objects you should press <Esc> twice: Once to unselect the objects and twice to deactivate the grips.

In each object the positions of the grips are different. Namely, for a point the grip is the point itself, for a segment the grips are the midpoint and the two endpoints, for an arc the midpoint and the two endpoints, for a circle the center and the quadrants, for a polyline the endpoints of the line and arc segments and the midpoints points of the arc segments, for a spline the spline points, for a block the insertion point, for text the insertion point etc.

2.3.6 Print

This section may be read after the user has created a drawing and wants to print it. Any drawing can be printed using a printer or plotter or to a file. Printing is performed using "PRINT" (or "PLOT") command, selected either from the "FILE" menu or typing it in the command line, provided there is a drawing already loaded.

Viewing a drawing before printing gives you a preview of what your drawing will look like when it is printed. This helps you see if there are any changes you want to make before actually printing the drawing.

If you are using print style tables, the preview shows how your drawing will print with the assigned print styles. For example, the preview may display different colors or lineweights than those used in the drawing because of assigned print styles.

To preview a drawing before printing

1. If necessary, click the desired Layout tab or the Model tab.
2. Do one of the following:
 - Choose File > Print Preview.
 - On the Standard toolbar, click the Print Preview tool.
 - Type ppreview and then press Enter.
3. After checking the preview image, do one of the following:
 - To print the drawing, click Print to display the Print dialog box.
 - To return to the drawing, click Close.

The Print dialog box is organized by tabs into two functional areas: scaling and viewing, and advanced printing options. For help defining print settings before you print, see Customizing print options.

To print a drawing

1. If necessary, click the desired Layout tab or the Model tab.
2. Do one of the following:
 - Choose File > Print.
 - On the Standard toolbar, click the Print tool. If you click the Print tool, the Print dialog box does not display. Your drawing will be sent directly to the selected printer.
 - Type print and then press Enter.
3. From the Print dialog box, make any adjustments to the settings.
4. Click Print.

2.3.7 Plus Drawing Tools

These tools belong to a large group of options under the general menu PLUS. These are a series of additional drawing tools, which have been embodied in the package in order to help the user during drawing, and are described within the Full User's Guide.

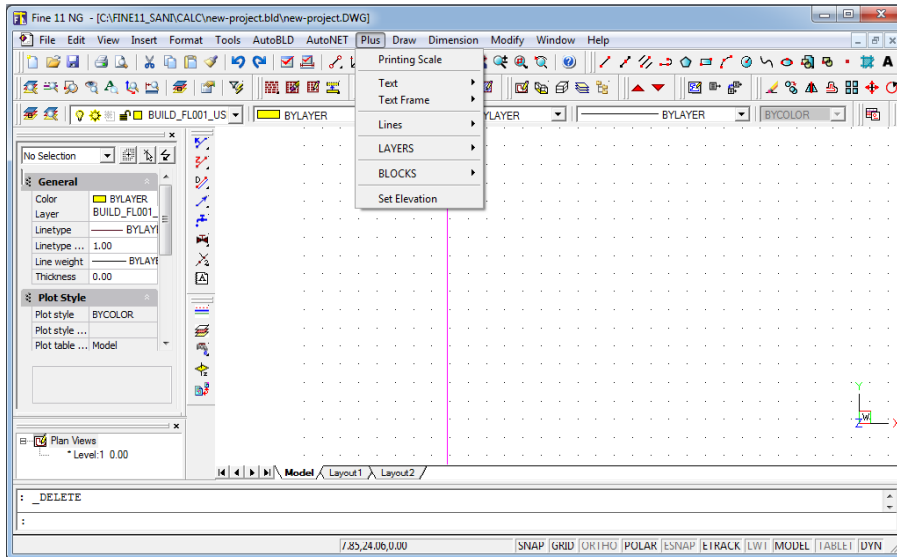

2.4 AutoBUILD: Architectural Drawing

The AutoBUILD option group, as we will see in detail below, includes all the facilities required to insert a building, that is to create an Architectural drawing. As it is shown in the corresponding AutoBLD menu, the various options are divided into sub-groups.

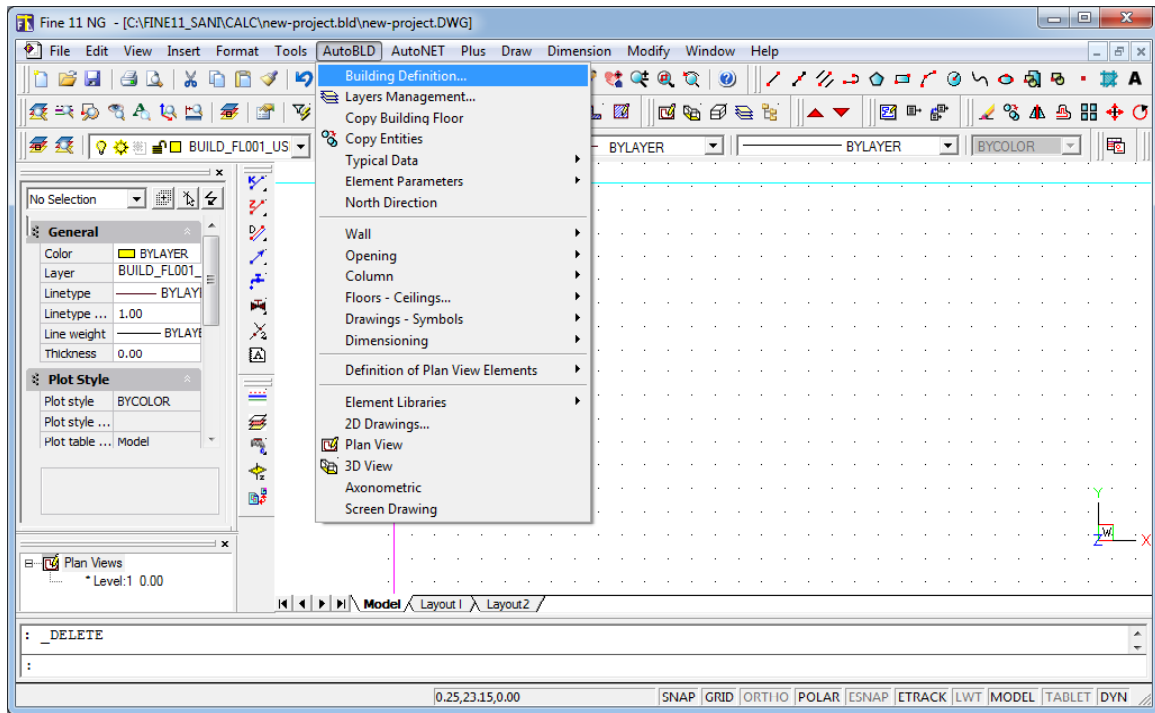

In general, the first sub-group includes commands for the definition of the project parameters, the second sub-group includes drawing commands, the third sub-group includes commands for linking to the calculations, the fourth sub-group includes management options for the AutoBLD libraries and also includes commands for the building supervision. In the following sections, the options reported above are described one by one, beginning with the "Building Definition" option.

2.4.1 Building Definition

First of all you should select the "BUILDING DEFINITION" command and the floor management menu appears.

On this screen the floors of the project building are defined, which means that you should determine the level and the corresponding architectural drawing (plan view-as xref) (DWG file) of each building floor (only in case you use a drawing that was created by another architectural designing program). More specifically:

- In the "Level" field, define the Level (floor) number.
- In the "Elevation" field, define the height of the floor level. The user may define manually a benchmark for level measurement (e.g. the pavement). You may also define negative levels (e.g. -3 m).
- In the "File" field, define the path and the name of the relevant DWG drawing-file, only if you refer to an already existing drawing (which means that you do not intend to draw the plan view from scratch). If there is no DWG architectural drawing available, leave the filename empty.

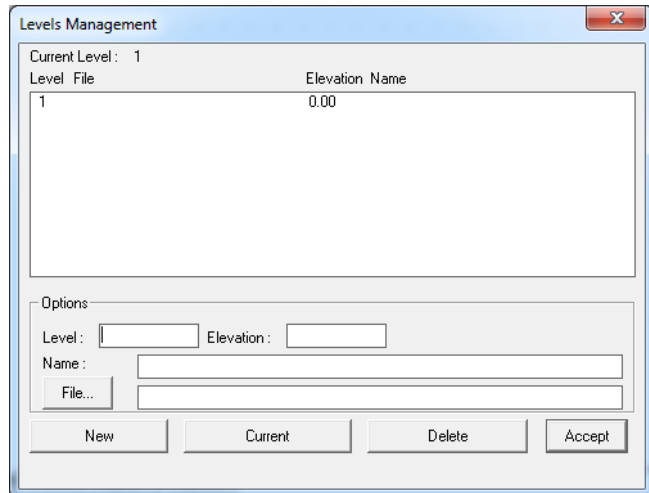

The insertion and the management of plan views are performed with use of the xref command. At the bottom of the dialog box there are three functions available which are actually used to manage the floor files. More specifically:

- Press the "New" button to save a new floor or the changes in the data of a floor (e.g. level, DWG drawing).
- Use the "Current" option to select the plan view/file you want to work on each time.
- Select the "Delete" option to delete the floor you want to (after you have it selected). The "Delete" command removes the plan view of the relevant floor in the project without deleting the original architectural DWG file.

The "OK" command closes the dialog box (does not save the floor data). This can be done with the "New" command). FineSANI enables also the use of a "scanned" plan view, which is a plan view in a bitmap file created by a scanner. In this particular situation you have to insert the .bmp file with the "Insert"->"Raster Image" command

The "Layers Management" option helps the user to define in a quick and very practical way which of the entities layers will be frozen during designing. If the user wants, he could freeze the layers of any element group, by simply clicking inside the indicator-box of the corresponding entity. When the box is checked, the layers of these entities are thawed.

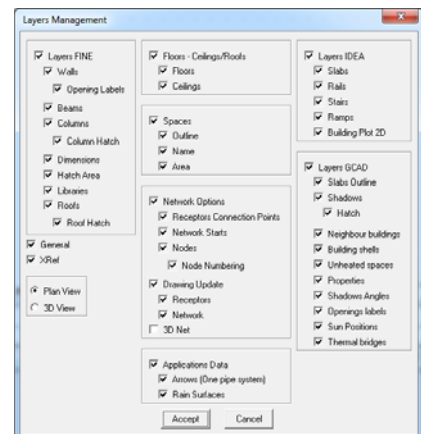

2.4.2 Drawing Walls

AutoBLD contains all the commands required for drawing and editing walls, such as trim, extend, join and break command. It also contains commands as to place openings like windows, doors, and simple openings-holes.

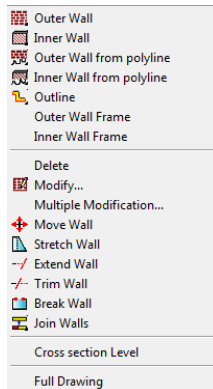

The **Wall** command, located at the second subgroup of the AutoBLD group of commands, includes the Outer, Inner, Outer wall from polyline, Inner wall from polyline and some editing commands like Modify, Delete, Extend, Break, Join, Trim and Move. Finally, there is also the “Cross Section Level” option, which affects the view plan drawing

presentation.

By selecting Outer Wall, first of all its attribute dialog appears with a series of parameters (type, dimensions, colors etc), which are described in detail within the User’s Guide.

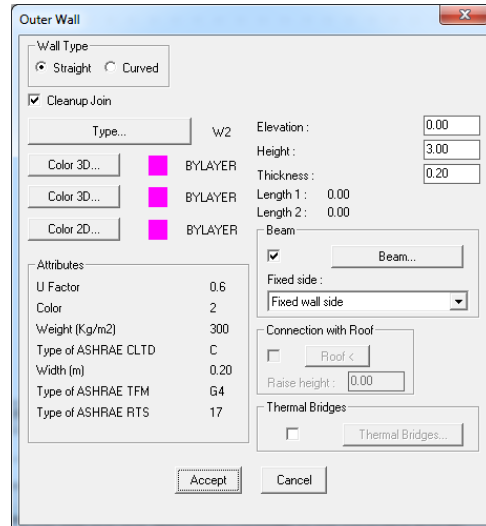

In order to start drawing a wall, you should click OK and then follow the instructions shown below:

Outer wall (straight / arc): After activating the command (by pressing <Enter> in the menu), you are required to successively provide:

- i) the starting point of the wall (the application message in the command prompt is: *“Wall start \ Relative to wall \ Toggle shape <Linear>”*)
- ii) the ending point of the wall (the application message in the command prompt is *“Wall end \ Relative to wall \ Toggle shape <Linear>”*)
- iii) the direction towards which the wall shall grow, by providing any point on one of the two half-planes defined by the wall line (the application message in the command prompt is *“Enter Side Point”*).

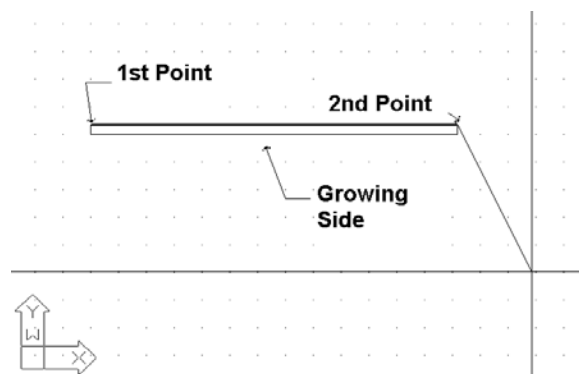

After the above actions, you can see that the wall has been drawn and that you can continue to draw another wall starting from the ending point you defined earlier, unless you press the right button of the mouse, which means that you want to stop. You can change the wall drawing from linear into circular, typing **T** in the following programme prompts and pressing <Enter>.

During drawing, one can come to the conclusion that the ability of drawing consecutive walls is very convenient, since it saves the user from making many movements.

As mentioned further below, in the “Element Parameters” section, the thickness of the wall, its height and its level in relation to the floor level (when the level is 0, the wall starts from the floor), are stored within the “Element Parameters” for the wall. By providing proper values for the wall height and level, any possible case of walls of unequal height can be dealt with. The techniques and tools for creating walls are described in detail within the User’s Guide.

Further to the drawing functions, the program also provides the user with powerful editing tools, such as erase, modify (through the wall dialog box), multiple change etc. Within the User’s Guide there are complete instructions regarding the above commands plus also the applicable commands Copy, Stretch, Extend, Trim, Break, Unify, Mirror, Rotate, Scale, Base point. Two other commands that are widely used while drawing the walls are a) the Undo command, which enables the user to reverse the previous command executed and b) the Properties command, which enables the user to view (and change) the attributes of the selected wall.

2.4.3 Drawing Openings

Once the command "Opening" is activated, a second option menu is displayed, including a variety of opening types (window, sliding door, door etc) to draw, plus also a set of editing functions such as "Erase", "Modify" or "Move", applied to existing openings. Besides, at the bottom of this menu lies the option “Libraries”, which enables the user to define his/her own opening freely, to create various shapes of windows.

Window: The option "Window" demands that you select the wall on which the opening will be placed and then define the beginning and the end of the opening (all these actions are carried out using the mouse and pressing <Enter> each time). The window will automatically obtain the data that are predefined in the “Attributes”, namely the corresponding values for the height, the rize, the coefficient k etc). Of course, you can draw the window from the plan view as well as in the three-dimensional (3D) view. During drawing a window, it is very helpful to the user the fact that, after the wall where the window will be automatically placed is selected, the distance from the wall edge is displayed in the coordinates position on the top of the screen, while the crosshair is transferred parallel to the wall for supervision reasons. The measurement starting point (distance 0) as well as the side (internal or external) are defined by which one of the two edges is closer and which side was "grabbed" during the wall selection. Similar functionality exists for other types of openings, such as Sliding Doors, Doors, Openings etc. All the details are included within the User’s Guide.

2.4.4 Other Entities

AutoBLD provides tools for designing columns and other elements, as well as drawing libraries including drawings and symbols to place within the drawing (i.e. general symbols, furniture, plants etc). Details are shown within the User Guide of FineSANI.

Finally, the Building model of a FineSANI project can be viewed through the commands:

- Plan View (2D): The two-dimensional plan view of the respective building level is shown.
- 3D View: A three-dimensional supervision of the plan view of the current floor (with given viewing angles) is shown.
- Axonometric: Provides three-dimensional supervision of the whole building (for all floors), with the given viewing angles as they have been selected in "Viewing Features".

2.5 AutoNET: Network Drawing Principles

The option group AutoNET includes all those tools the designer needs in order to draw (and then calculate) the Sanitary installations. More specifically, the main AutoNET instructions are described below:

Drawing Definition: Layers for each installation are organized properly and the information is shown on the respective dialog. The command "Color" is used to assign the desired colour to each network while the command "Linetype" is used to select the desired line type.

Applications Layers Management: This command leads to the adjacent dialog screen, where you can activate more than one installations and monitor those which are possibly overlapping (i.e. both Water Supply and Sewage networks at the same time).

Copy network of Level: AutoNET enables copying of typical (installation) plan views and pasting them on other floors through this command, which functions similarly to the "copy level" AutoBLD option.

Select Application: This option enables selection of the desired application of FineSANI, the Water Supply or the Sewage. Depending on the selected application, the section of the following AutoNET menu will be configured accordingly.

The basic principles and rules for drawing a network are described below:

Network Drawing: The installation network drawing is carried out with a single line, by drawing lines and connecting them to each other, exactly as the network is connected in fact. The user should keep in mind some general principles regarding drawing and connecting between straight or curved, horizontal or vertical network branches.

Horizontal & Vertical Piping: In any case, the piping drawing is carried out exactly as the line drawing (in Autocad or 4MCAD). The user is able to draw horizontal or vertical network branches. Note that vertical branches are different from columns, which will be described below, as they are within the borders of the active floor and do not "cross" floors like columns. The pipe installation elevation is the current elevation. Modification of the pipe installation elevation is possible through the command "elev". If you type "elev" (in the command line), you are prompted to determine the new current elevation. Press <Enter> if it is 0 or type 0 if there is another value but 0. At this point it should be emphasised that, if a horizontal piping which is found on a specific level is drawn and it is connected to another piping or a contact point (receptor), the program automatically "elevates" or "lowers" the pipe so that connecting to the other pipe or receptor, respectively, is possible. In this way, the programme facilitates the drawing of piping in three dimensions while the designer is actually working in a two-dimension environment. In any case of a network design, all facilities provided by AutoCAD can be utilised through relative co-ordinates.

Column Drawing: Drawing vertical branches which cross floors (one or more) is possible through the option "(Building) Column". When the respective option is selected from the menu, the programme asks for the column position ("Enter xy Location") and then for the height of the starting point ("Enter Height for First Point") as well as the height of the ending point ("Enter Height for Second Point"). For example, if you want to draw a vertical branch (column) from 0 to 3, by inserting the location point (XY) and then the numbers 0 and 3 successively, the symbol for direction change appears on the plan view and in 3D View.

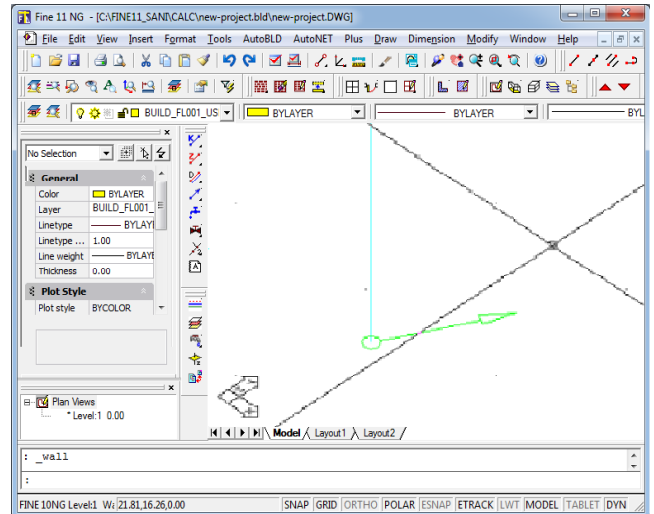
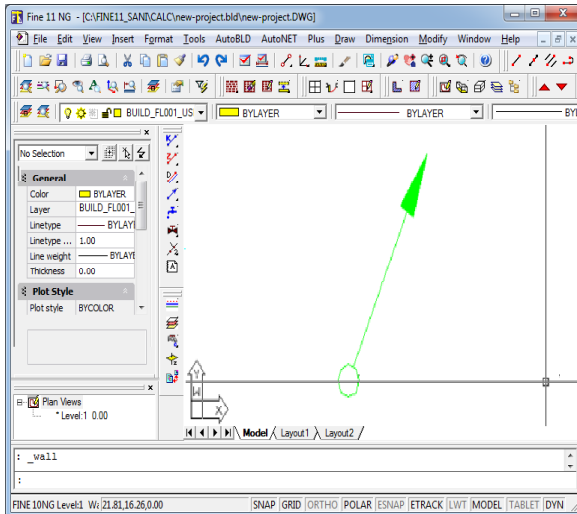

Vertical branches within the same floor: If you want to elevate or lower a pipe within the same floor without having the elevation-lowering symbol inserted (Mark1), you can use the command "Pipe", having a common functionality to the line drawing. You can draw piping in 2D or 3D drawing mode.

Drawing of Curved Pipes: Draw curved pipes by inserting the points from which the curved pipe is to pass. The respective command prompts for the following:

- First point: Insert the starting point of the pipe.
- Next point: Insert next point, the one after that and so on (successively), defining the pipe routing in this way.

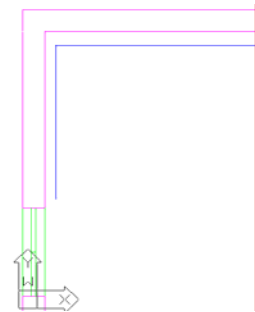

The user can easily modify curved pipes using "grips". As soon as the pipe is selected, grips appear which you can move, altering this way the pipe routing. In the Bill of Materials and the Calculations phase, the program will measure the pipe length precisely.

Connecting network sections: Connections between network sections (horizontal, vertical or both) as well as between network parts and receptors can be easily executed by using the CAD "Snap" commands. For example, suppose that the two horizontal parts of the plan view below, which are placed in different heights, have to be connected. If you start by "grabbing" the "upper" pipe end and then end up at the "lower" pipe end, the result in the three dimension representation will be as on the right.

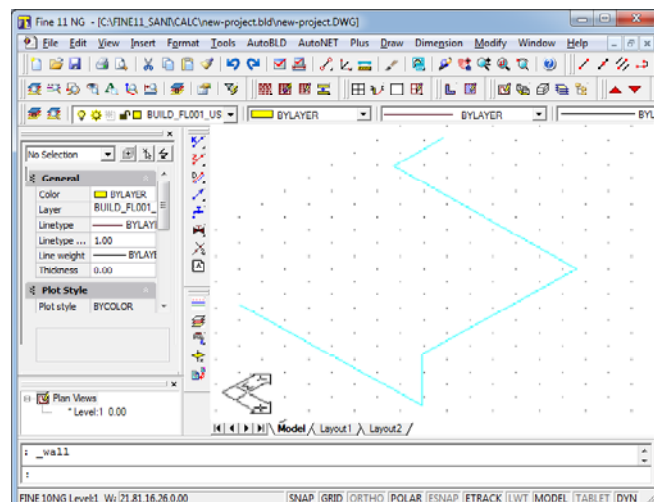
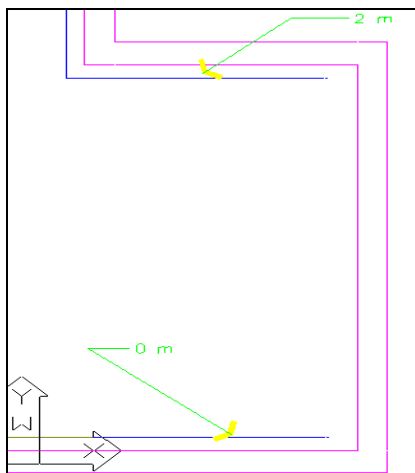

Special Commands for Pipe Construction: This is actually a set of commands aiming at the facilitated drawing of the installation piping. More specifically, there are two basic commands:

- **Double Pipe ->Supply-Return:** A double pipe (e.g. supply-return) can be drawn, when the in between distance is known, by simply defining the routing.
- **Pipe parallel to Wall:** A pipe parallel to the wall (walls) marked by the user is drawn, with a given distance from the wall, in printing mm (which depends on the printing scale as well). The program asks for the first point and afterwards the wall or the walls (successively) parallel to which (in a certain fixed distance) the pipe is to be drawn. For instance, if the connection point of the tub is inserted as the first point in the plan view detail shown below and then the three walls of the room are "marked", a pipe parallel to these walls will be constructed.

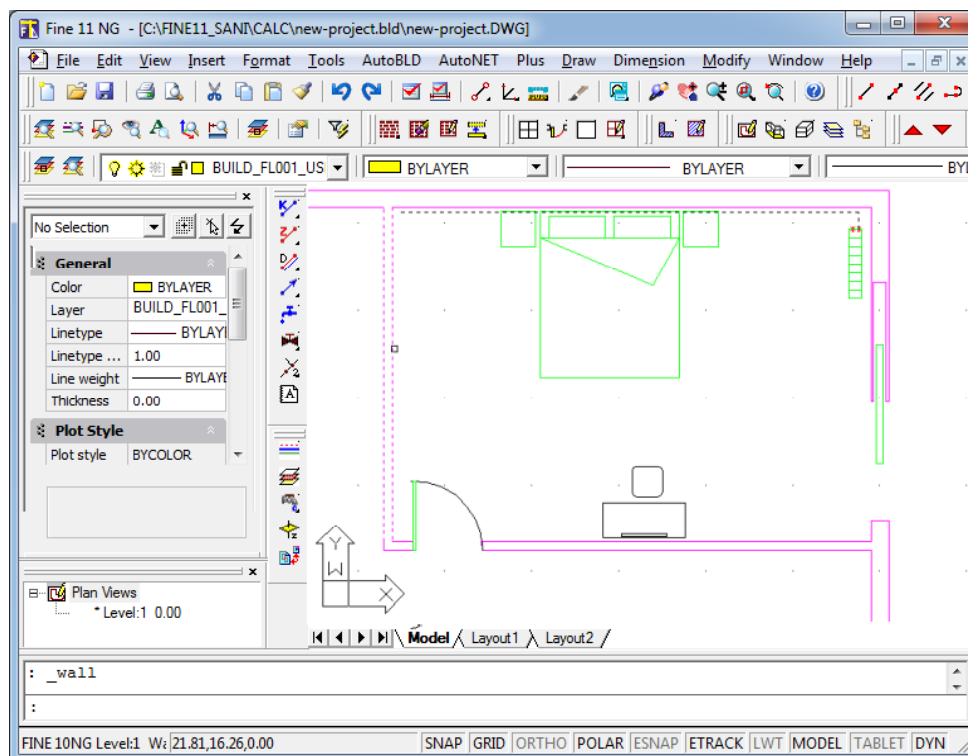

The reason for that is that the program draws a vertical line from the first point to the parallel line defined by the other two points.

Pipe parallel to Points: A pipe is drawn parallel to the points defined by the user (supported by automatic snap), with a given distance from the crooked line defined by these points. The program asks for the first point and then for the other points (successively) parallel to which it is desired to have the pipe drawn. When all points are inserted (and you right click), the distance will be requested.

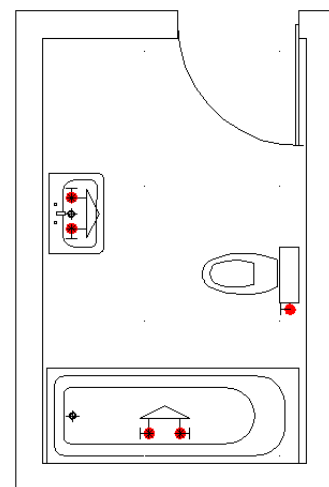
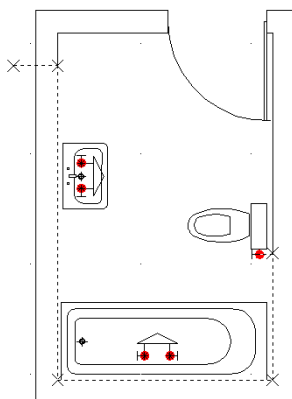

Pipe parallel to Wall (or Points) and Receptor Connection: This is a particularly useful command similar to the two commands above "Pipe parallel to wall" and "Pipe parallel to points", which, however, enable selecting the receptors to be connected on the routing (piping or wiring) which will be drawn parallel to the walls or the points. Therefore, it is possible to connect a whole set of radiators to the nearest vertical column, or grills to the corresponding Air-duct, or multiple illuminators to the main panel, with 2-3 moves.

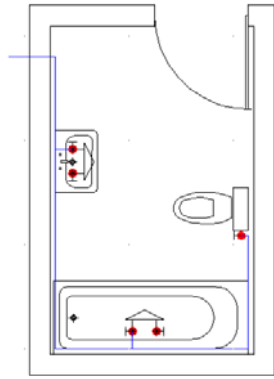

For better understanding of the command function, assume that in a given bathroom with its receptors it is desired to install a pipe parallel to the wall and connect the receptors to this line. The steps are the following:

- Select the "Cold water pipe parallel to points and receptor connection" command and the following options will appear:
- Select receptors: Select the receptors to be connected to the pipe applied in a parallel arrangement against the wall by defining certain points on the wall.
- Enter the 1st point & Enter the next point: Provide the points parallel to which you want to install the pipe. The points are shown on the drawing with an X.
- Distance from a point <1.00>: Provide the distance in printing mm where the pipe is going to be drawn starting from the inserted points.

The program draws the pipe and connects it to the receptors.

Modifying an existing network: The user can edit an existing network by using any CAD command (i.e. copy, move or erase etc of a network section) or utility (i.e. grips) during the design process. The only rules to apply are the following: Pipes supplying the appliances (receptors) should be connected to the touch points of these receptors. Obviously only one pipe can be connected to a touch point. The connection with the touch points which appear as "stars" in the plan view can be executed with the "osnap" function. If the receptor is equipped with more than one touch points, as in the water supply for example (hot and cold water), then each touch point is used for the respective network (e.g. hot and cold water network regarding the water supply), regardless of which of the two touch points will be selected (the network automatically defines the touch point, that is the point where the hot water pipe ends up and this touch point automatically becomes the receptor hot water supply). Piping can be branched to one another and extend in any way as long as they do not form loops, something which does not apply to reality anyway. If however a mistake occurs, the program (during the identification procedure) will perform all checks and indicate the mistake and its location to the user. A necessary step before the "identification" (recognition) is defining the point (1) where the network starts, that is the supply point (1). In reality, this point corresponds to the water supply point from the city network. In the case of two different networks (e.g. hot and cold water network in the water supply) the respective supply points, bearing a different symbolism, should be defined for each network. Especially for water supply, the hot water supply points to heaters or boilers should be defined. In both FineSANI applications, Water Supply and Sewage, the menu includes the specific options, so that the user can be easily guided when drawing any installation. Although there are no limitations regarding the order of actions followed in drawing an installation, the following order is suggested:

- Receptor Placement (radiators, hydraulic receptors, grills etc)
- Drawing the piping columns
- Drawing the horizontal sections
- Defining the Supply point(s)

- Network Recognition

Placing receptors: Locating a receptor can be done simply through the following steps:

- Select a receptor, press <Enter> and then press "OK" (or alternatively double click). Then it can be observed that the receptor moves on the plan view with the graphic cursor.
- If you move the mouse properly, the receptor can be carried in such a way that its base point (which coincides with the cross of the graphic cursor) can be placed in the desired point. Right click to confirm your selection.
- If you move the mouse again, the receptor will rotate around the base point. Thus, if you confirm the angle in which you desire to have the receptor placed (again by right clicking), the receptor "freezes" in its final position.

You can also insert and place either the whole receptor or only its touch points in the plan view. This is significant when an existing plan view includes drawn hydraulic receptors and there is no need to redraw them, but just move the touch points so that the information for the respective supplies will be available. Selecting the whole receptor or the touch points only is facilitated by the correspondent indications on the upper side of the receptor screen, which should be activated by using the mouse properly. Regarding the installation height of a receptor, it should be pointed out that receptors are always installed in the current height. The current height can be changed with the "Change Height" command.

Fittings: The "Fittings" command selects the accessories to be also inserted in the drawings, which applies exactly the same to the receptors. Fittings have "touch points" upon which the piping will be connected so that the network can be identified. A symbol may also have more than one touch points (e.g. a collector), in which case the accessory will be numbered as a junction point in the "Net Recognition". The program provides the capability of cutting off the line automatically when a symbol is inserted on the line, exactly where the accessory interjects. This capability is defined by the indication of the accessories box "Break Pipe". If this option is activated, then the program will automatically "Break" the pipe when the accessory is placed.

Moreover, the "Move Symbol" indication is in the same box, which defines whether the accessory will be moved in relation to the position it was initially placed (so that it will be placed parallel and on top of the pipe) or the pipe will be moved (so that the accessory can be attached).

Symbols: "Symbols" include various general symbols, layout of machines (i.e. pressure units) and other drawings that can be used in the corresponding installation.

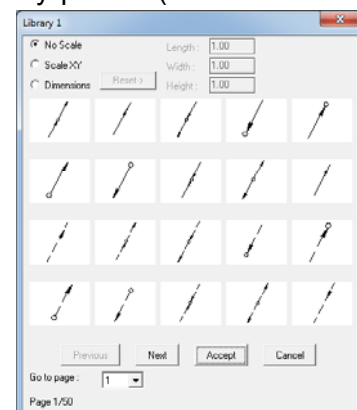
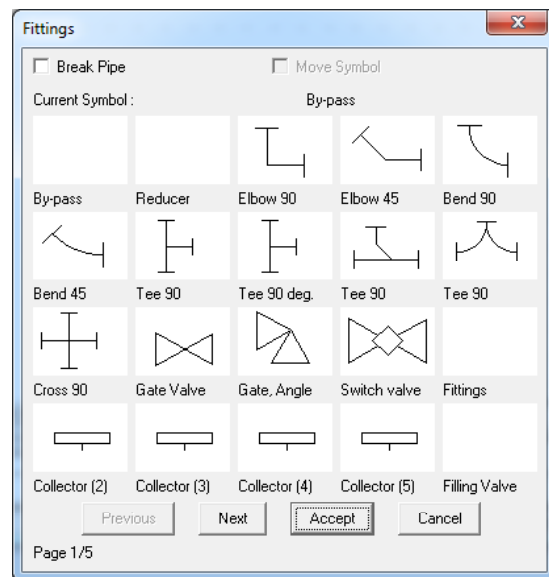

Network Recognition and Numbering: Since the network has been drawn according to the current rules and the supply point has been determined, the "Net Recognition" option converts the network in the required standard pattern and updates appropriately the calculation sheets. During updating, junction points and receptors are numbered on the plan view. Note that if a receptor is not numbered, means that the receptor is not connected to the network. Besides, if a network section has a different colour it cannot be connected to the network. Connect it or select "Break at selected point" at the connection point with the previous pipe.

Calculations: The "Calculations" option leads you in the corresponding calculating environment (ADAPT/FCALC), which means that the window of the current application is "opening", while FINE always remains "open". In order to transfer the data from the drawings, you should select "Update from Drawing" in the menu "Files" of the corresponding calculating application (In order to carry out the corresponding calculations, answer "Yes" to the question "Calculate" that appears). From now on, apply all the capabilities mentioned in the ADAPT/FCALC User's Guide for the respective application. It has to be noticed that the numbering of the sections, the lengths of the network sections, the receptors with their supplies and the accessories (from the piping routing) are transferred in the calculation sheets. Of course, if the user wants to, he can intervene in the calculations in order to make any modifications.

Legend: The "Legend" option creates a legend with all the symbols that have been used in this specific project. By selecting it, the program asks for the location where the Legend is going to be inserted. Use the mouse to define the location and the legend will appear automatically on your screen, exactly under the location point.

Vertical Diagram: This option is used for the automatic creation of the vertical diagram of the installation and in its appearance on the screen, within few seconds. In case there is already a vertical diagram, the program asks if you want to update it. It is obvious that, in order to create a vertical diagram, you should draw and identify a network and enter the calculation sheets, so that the program knows all the data needed for the vertical diagram creation (pipe dimensions, junction points numbering, etc). By the "creation" command the window of the vertical diagrams manager appears on screen. This window is composed of two parts, the part with the network tree and the part with the vertical diagram. Through appropriate commands, the user can intervene in several ways on the output of the diagram:

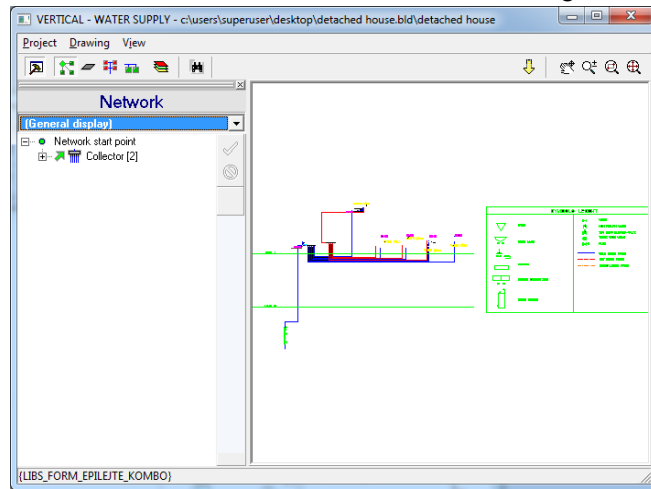

- Enable or disable various branches of the network
- Change the order of the columns of subnetworks in the vertical diagram
- Change the subnetworks direction connection on the vertical columns (right or left)
- Read the information of each node
- Describe the subnetworks

The changes done in the vertical diagram with the help of the above icons are displayed in real time, in the second part of the window. On the upper side of this window there are also icons for processing the diagram (real time zoom and pan, zoom extends etc). In addition, in the upper-left side there are some other icons having to do with the appearance of the screen, such as the hiding of the left part of the window, the appearance of the level names and heights on the left to be edited, the appearance of the numbers of the receptors, the layers and others.

Finally there are some options for the initialization of the vertical diagram, its recreation and the definition of the drawing parameters. In particular, these parameters depend on the application and include the following options:

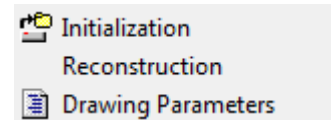

Layers: Through a supervisory window table, The user can define the drawing scale, the colours corresponding to the various layers and the height of the texts (in mm drawn on paper) placed on the vertical diagram.

Drawing dimensions: The drawing dimensions that will be considered on the creation of the diagram, are also defined on mm drawn on paper.

Blocks: There can be defined on each application different network starting points and type of tables. The user can choose from a set of dwg drawings.

Others: A set of attributes concerning the form of the vertical diagram is defined, such as the condensation of the columns, the number of branches over whom the node is considered as collector, whether the z height information will be considered in the diagram creation and whether the sub-networks pipes on the vertical diagram will be placed over or under the receptors. Finally, it should be mentioned that during the editing procedure concerning the vertical diagram manager, if there are mistakes the program displays the proper messages and warnings.

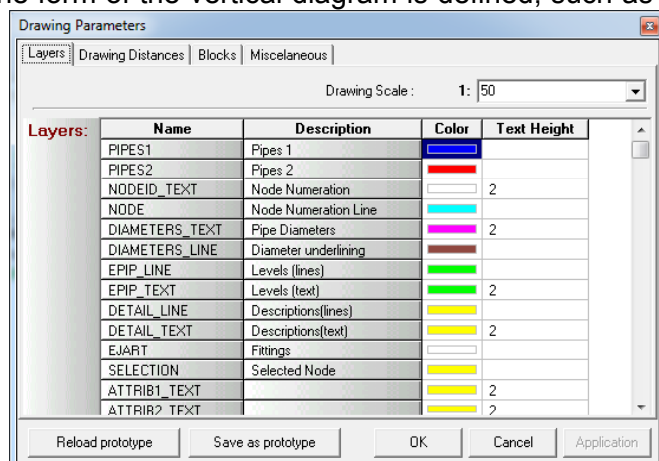

Library Management: The Library Manager leads to a submenu including the options "Numerical data" and "Drawing data". The first option leads to the libraries with all the numerical data of the materials. The "Drawings" option leads to a dialog box where the following data can be seen, regarding each application.

2.6 AutoNET: FineSANI Installations

The previous chapter described the drawing principles, while this one **describes those commands in relation to the special features of FineSANI** modules, Water Supply and Sewage. After selecting an application (e.g. Water Supply System) via the menu "AutoNET > Select Application", you can elaborate the water supply system design, completing the design drawings at the same time. After completing the water supply system, you can select the Sewage system application via the "AutoNET > Select application" menu and elaborate the relevant design. Selecting the "Sewage System" application, you can see that the layers regarding the Water Supply System application are now frozen and the layers regarding the Sewage System are now active. If, while designing, you want to view the Water Supply System and the Sewage System networks together, select "AutoNET > Manage application layers" and click the "Water Supply System" and the "Sewage System" checkboxes.

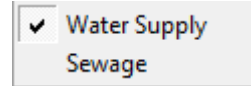

2.6.1 Water Supply System

Regardless the fact if there is an AutoBLD building model, an on xref or digital image or even no architectural drawings, a water supply installation can be drawn and then calculated. By selecting "Application Selection" -> "Water Supply", the relevant toolbar appears and the menu takes the form appearing on screen.

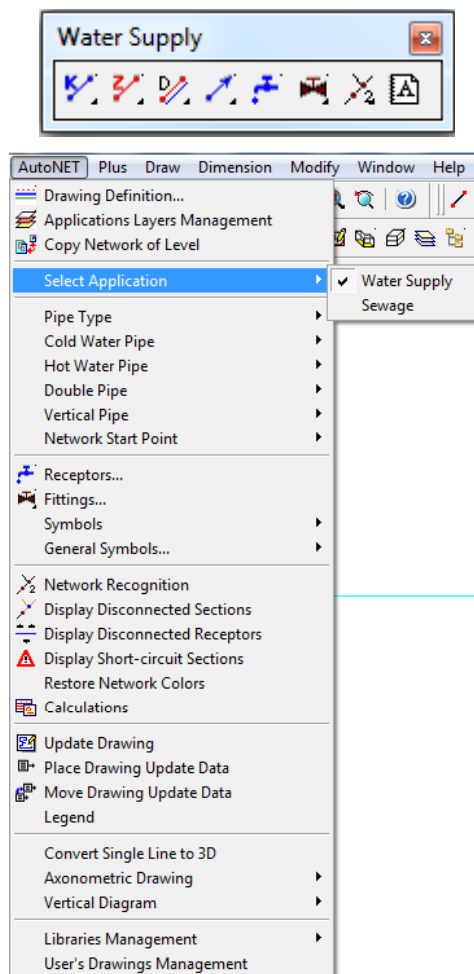

Placement of the Receptors to the draws: We select “Receptors” either from the AutoNet menu or from the “Water Supply” toolbar. When all receptors' windows appear, the user selects the type of receptor, which will be placed at the specific point.

The receptors are placed as referred earlier. In case they already exist *on the architectural plan view, then we just click at the “Contact points” field.*

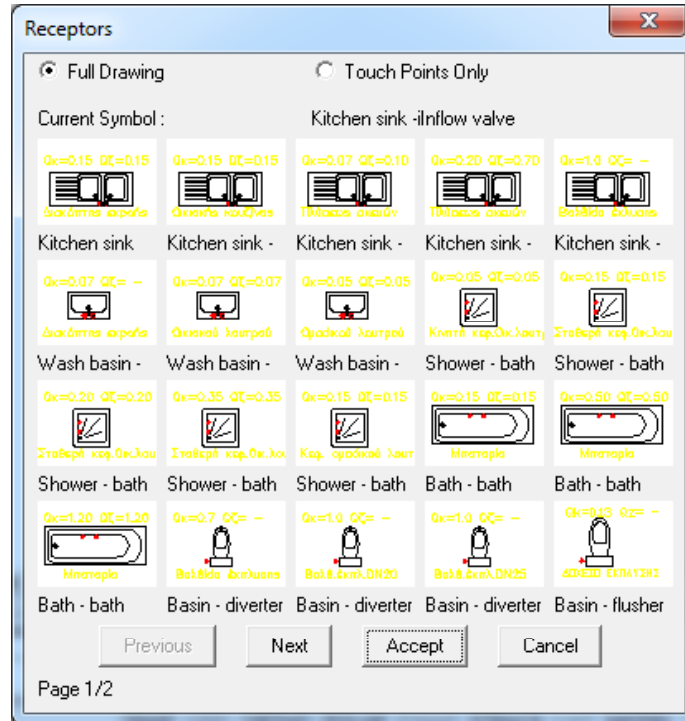

Horizontal networks design: Here we'll select the type of installation. There're two major ways, the first incorporates piping passing through the walls and the second features piping that passes under the floor and a distribution board. It is advisable to be aware of both methods, because they can be used in a mixed system. The next step is the marking of each pipe in the network as a primary or a secondary. The toolbar of the following image allows us to mark each pipe easily.

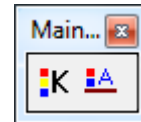

Design of a water supply system featuring under the floor distribution: We place on the draw the cold and hot water collectors (the later will be fed by a water heater). The placing of the collectors is performed through the “Elements” command or from the “Water Supply ” toolbar. From the displayed dial box we select the appropriate collector. The collectors' connection points are merely designing symbols allowing us to connect later more than one circuit pipes, resulting to 10 receptors the most.

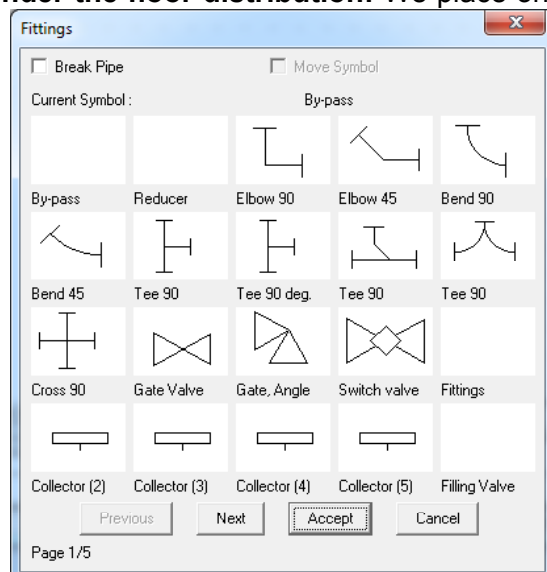

Vertical bend ducts design – connection of the receptors: The next action is the design of the circuit pipes. This is performed always starting from the hot or cold water collector to the receptor, where we form the curving part. Note that three points are required in order to determine a curving pipe. When we design the circuit, with the use of receptors, we must be aware that the programme designs the curved part of the pipe in **elevation=0**. The placement of receptors with **elevation=0** is recommended. The design command can be selected either from the “Water Supply” toolbar, or the AutoNET menu:

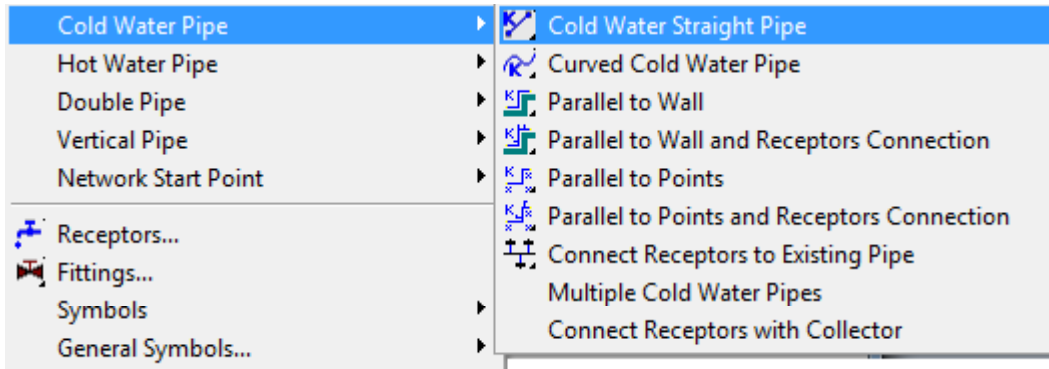

One of the selections in the AutoNET menu for both the cold and cold water is the **“Connection of receptors using a collector”**.

The connections of the receptor to the collector, for both hot and cold water, are performed completely automatic if we choose one or more receptors and a collector (e.g. in a altogether window) allowing the programme to perform all connections from the collector to each receptor; the only interference of the user will be to insert the curving of the pipe. At the following example, if we set a window encompassing the collector and 2 receptors we'll have the result displayed. The specified

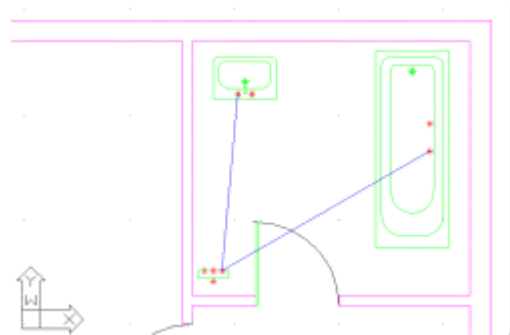

set of actions is repeated for every space of the level (kitchen, bath and wherever there're receptors) and for each separate level. We must note that in each collector we can connect another one. This means that from a central collector, which can be installed at the bath we can feed another one installed in the kitchen. All is left then is to connect with a straight pipe the main cold water collector to the central supply pipe (column).

Design of a system featuring a piping passing though the walls and connection of the collectors: After we place the connectors, as described earlier, we proceed with the design of the vertical and horizontal pipes of the level. After the design of the vertical and horizontal pipes, we perform the connection of the piping to the receptors. For the reduction of both the time needed for the specific work and of the errors we suggest the use of the “Connect of receptors with the existing line” (hot and cold network) command, analyzed within the User's Guide.

Design of the networks' Columns: We fix position and the starting-ending height of the vertical columns at the ichnography. Note that in most cases we provide the level only with a cold water column. In case we have a storage boiler or a sun heater, or for the provision of hot water of a maisonette, we use a hot water column. We must point out that the heights of the columns are dependent upon the level heights of the building. All ducts will be connected to the vertical columns through the “Vertical” heave point. The display of the column is indicated by the dot in the center of an arrow and not the small arrow. It displays the vertical column in the draw. In the case that the floors are of standard dimensions, we can take advantage of the “Floor network copy” command.

Set of Hot and Cold Water Supply Points: From the edge of the vertical columns, using straight pipes, we design the piping section ending to the supply points (counters). According to their number, we set equivalent network principles, more specifically, “Cold water supply”.

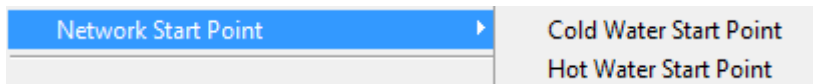

It is important to set the **ending** of the pipe using esnap.

Special reference must be done for the water heater. The water heater is connected to the cold water collector – to the connection point – as a receptor.

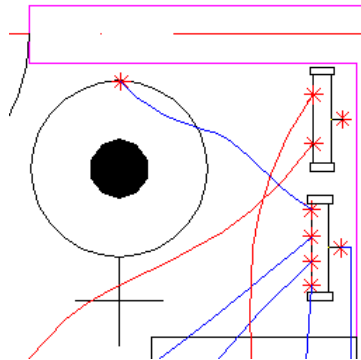

Next, using a straight or curved hot water pipe we connect the feeding of the collector with a point next to the water heater. There we place the beginning of the network (“Hot water supply”) always using as a heave point the end of the pipe. Note that the “Beginning of the network”, particularly the “Cold Water Supply” are used as a counter for the programme. We double check if the beginnings of the network have been placed everywhere (hot – cold water feedings). This completes the set of actions needed for the recognition of the network.

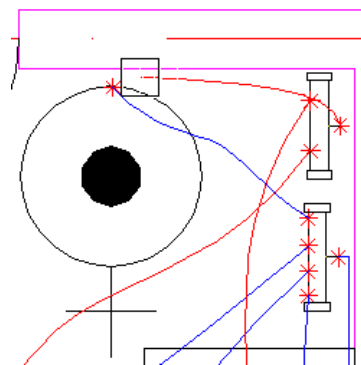

Network recognition: Select “Network recognition”, in order for AutoNet to recognize the logic as well as the position of the receptors in the spaces and to prepare the files for the connection with the calculations. During the recognition of the logic, messages warning the user for drawing errors may appear. For example there might be closed routes of the hot or cold water points at which different types of pipes end, lack or false placement of the beginning of the hot or cold water network, elements unconnected etc. Besides, no “white” parts should appear on the network, which means that they haven’t been “recognized”.

Calculations: When the control is completed we’re ready to go to the computing environment. By selecting “Computations” the Water Supply computations are displayed in AutoNet. When select “Files” and “Update from design”, the data is transferred at the calculation sheet.

Update Drawing: After the study on the calculation part of the program is completed, we save the project file. We refer back to the drawing programme (FINE) and select “Update Drawing”. Then the calculation results are transferred to the drawings. If this procedure is repeated, the program will ask if the user wants to delete the previous update and replace it with the new one.

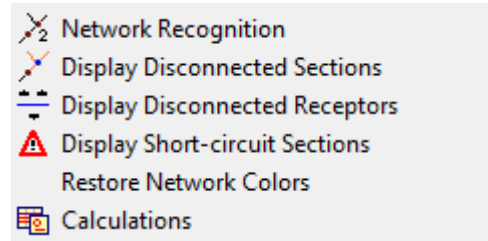

Other drawing actions – Completion of the draws: Next, we place a control faucet in front of each apartment or property, or wherever else it is required. The placing of the faucet is performed through the “Elements” command or from the “Water Supply ” toolbar. From the dialogue box we select the faucet having checked the “Pipe Cutting” box. We select the pipe and place the faucet. Next, we must place the counters (flow-meters). The draws regarding the counters, general assemblies manufacturing details and so on can be selected from the respected AutoNET databases or from the “Water Supply” toolbar and the corresponding icon.

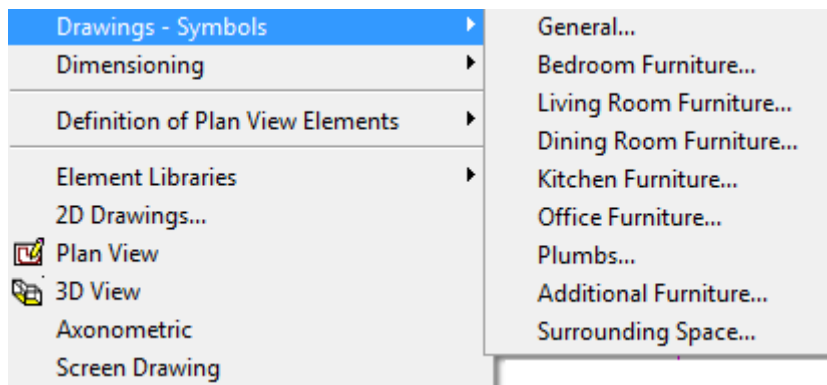

Finally, we can attach a legend.

Vertical Chart: The vertical chart is produced automatically with the use of FINE provided that the network was designed at the specific programme. From AutoNET we select “Vertical diagram” > “Create”. Then the following window appears:

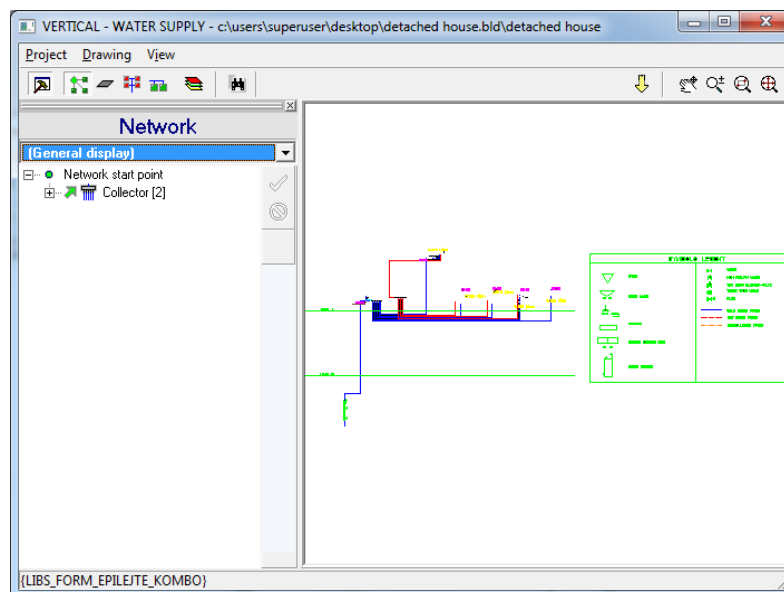
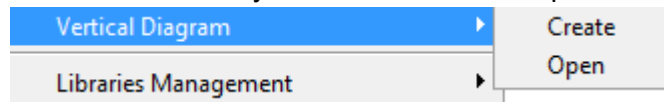

The user can apply all desired changes or close the window, which will result to the display of the design in a DWG form, which can modify using the provisions of CAD programmes. Details regarding the function of the vertical diagram maker can be found in the User's Guide.

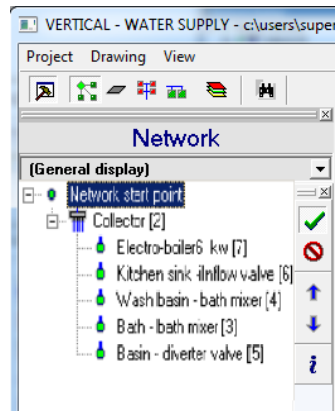

Example: A water supply network, featuring both hot and cold water segments.

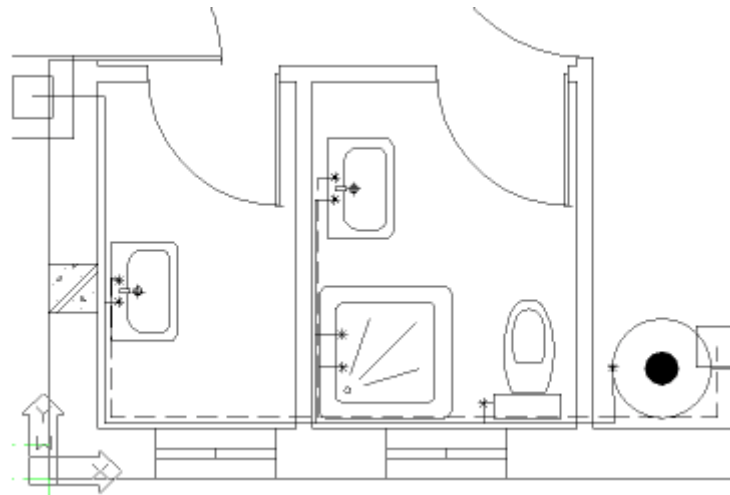

Just observe the hot and cold water feeding points, with the first located at the supply counter and the second close to the water heater. At the water heater connection point ends up the feeding duct of the cold water. The specific example can be used in order to compile any type of installation. When referring to an apartment block there're separate counters, when referring to other buildings, like workshops or hotels we have a central counter. The next example illustrates the alternative way of network design, which features networks under the floor.

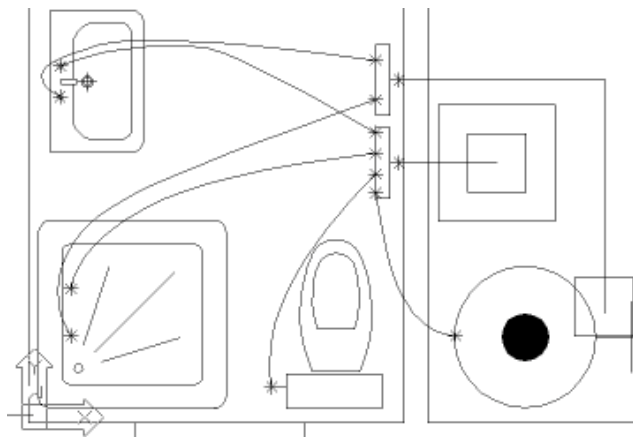

2.6.2 Sewage

By selecting “AutoNET” -> “Application Selection” -> “Sewage”, the following menu appears:

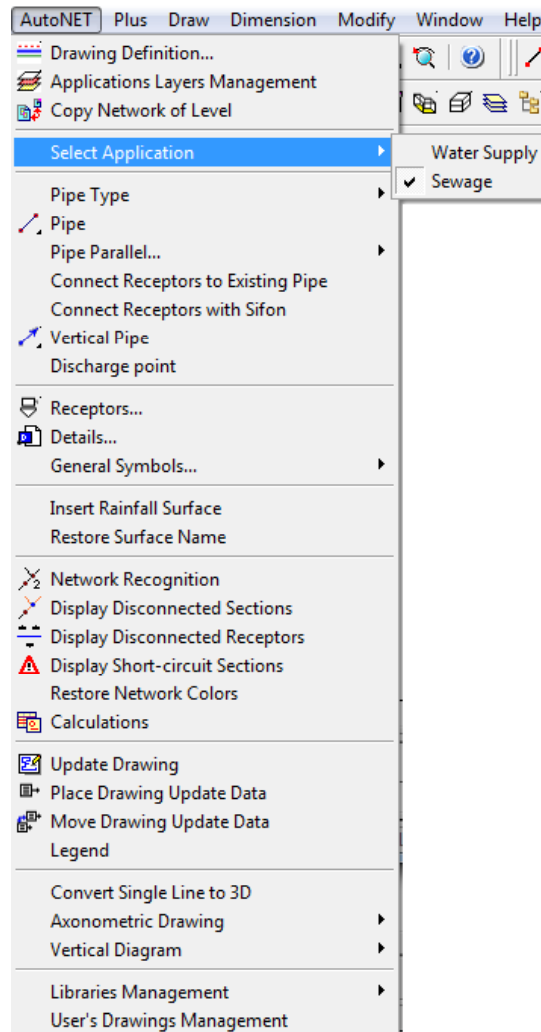

The first step is to design the sewage piping network.

Placement of Receptors: You can select the option “Receptors” either from the AutoNet menu or from the “Sewage” toolbar. When all receptors' windows appear, the user selects the type of receptor which will be placed at the specific point. The receptors are placed as referred earlier for the Water Supply application. If the receptors are put on the architectural design, you can click at the “Contact points” field. It is also here recommended to design with elevation = 0.

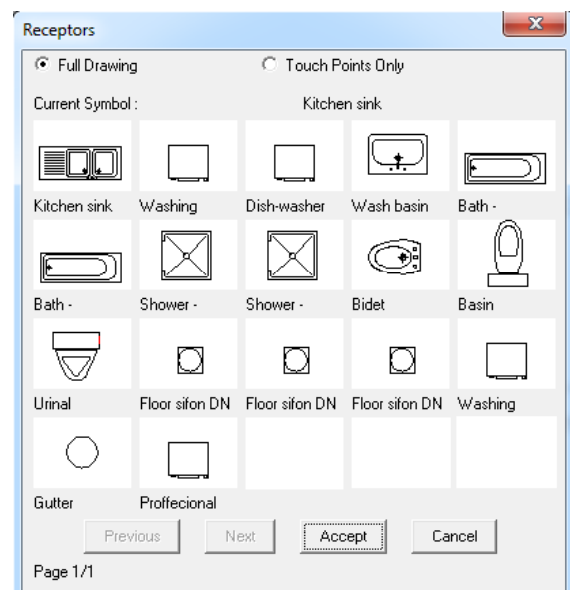

Drawing the Columns: You must define the position, as well as the starting and ending heights of the vertical columns at the plan view. It is pointed out that the given heights of the columns depend upon the level height of the building.

Drawing the horizontal pipes: You can draw the horizontal pipes, which will be connected to the vertical columns. The commands can be selected either from the “AutoNET” menu or from the “Sewage” toolbar. All ducts will be connected to the vertical columns through the “Vertical” heave point. The display of the column is indicated by the dot at the centre of an arrow (the projection of the vertical column at the plan view) and not the small arrow. Contrary to other applications, it is simpler to draw the network at a certain level due to the fact that no line up and downs are required. All network lines have “0” altitude.

Connection of the ducts with the receptors: Next, the connection of the piping to the receptors takes place, using the connection point. In order to minimize the time needed and the possibility of a drawing error, it is recommended to use the “Receptor connection with a drain tap”, provided that there is one available. If you select one or more receptors and a drain tap (e.g. altogether in a window), the program will automatically perform all the connections as well as the branching at the drain tap so that the proper identification of the network is ensured.

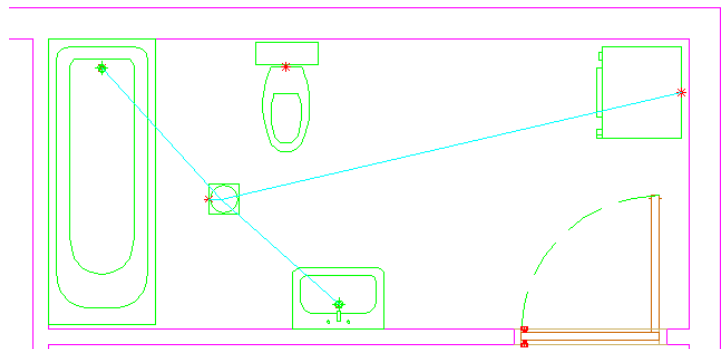

On the other hand, you can use the already known way of connection with the use of the receptors’ connection point along a piping. For the proper drawing of the connection of the drain tap to the receptors as well as to the runoff duct please observe that, as is displayed at the following image, the ends of the pipes meeting the receptors, a small section coming from the drain tap connection point, and the runoff duct meet close to the centre of the drain tap and not at its connection point. In the case that the floors are of standard dimensions, you can take advantage of the “Copy floor network” command.

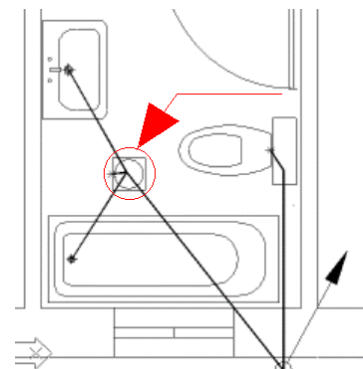

Determination of the Runoff Points: From the edge of the vertical columns, using straight pipes, you can draw the piping sections up to the runoff points. There, you can set the starting point (or points) of the network, by selecting from the “Runoff Point” menu.

It is important to set the **ending** of the pipe using esnap. The specific ending can either be at a point prior to the centre sewage duct or a cesspit (dry or absorbing).

Rainwater Network: When the feculent network is completed, the rainwater network must be drawn. At the “Feculent pipe” toolbar you can press the left mouse button and the toolbar changes its name and form.



It is now named “Rainwater pipe”

Placement of Receptors: *From the menu or the toolbar you can select “Receptors”.*

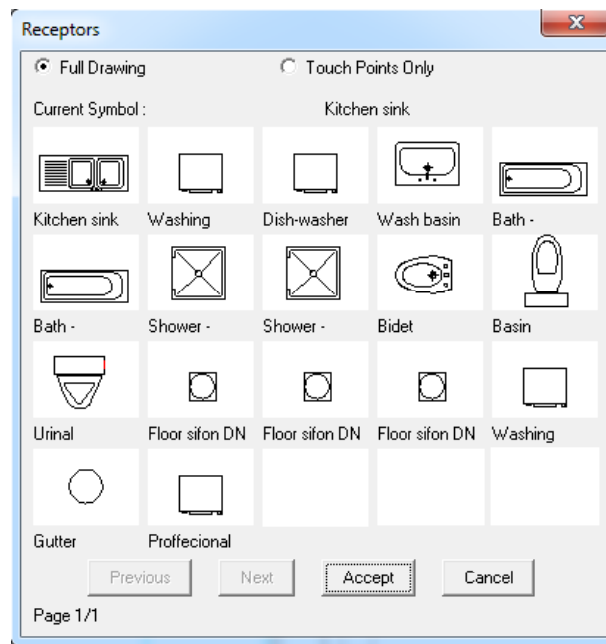

At the pop up window you can select the “Drain pipe” receptor. Note that “Drain pipe” means the end of the drain pipe which surrounds the roof of the building. In other words, it means the starting point for the downfall of the rainwater through the vertical pipe. If it is a “drain pipe” placed in balconies it refers to the floor drain tap. Thus in both cases it refers to the end point of the vertical part of the pipe, the one end of which is connected to the vertical column.

Drawing the Columns: Here you can define the position and the starting - ending height of the vertical columns at the plan view. It is pointed out that the heights of the columns depend upon the level heights of the building).

Drawing the horizontal pipes: Here you can draw the horizontal pipes, which will be connected with the vertical columns. You can select the commands either from the “AutoNet” menu or from the “Sewage” toolbar. All ducts will be connected to the vertical columns through the “Vertical” heave point. The display of the column is indicated by the dot in the center of an arrow (the projection of the vertical column in the plan view) and not the small arrow. Here it is simpler to draw the network due to the fact that no line up and downs are required. All network lines have “0” altitude.

Connection of the ducts to the Drain pipes: The connection of the piping to the drain pipes will take place with the use of the connection point of the receptor. In case that the floors are of standard dimensions, you can take advantage of the “Copy floor network” command.

Determination of the Runoff Points: From the end of the vertical columns, using straight pipes, you can draw the piping section up to the runoff points. There, you can set the starting point (or points) of the network, by selecting from the “Runoff Point”. It is important to set the **ending** of the pipe using esnap. The runoff can be a free one; e.g. a curb or a predetermined point at which the rainwater will be gathered prior to their ending at the city rainwater duct. Besides, as determined by the program, the feculent pipes are marked with blue color and the rainwater pipes with green color.

Insert rainwater surfaces: With this command, the user can determine the surface area where the rain falls, as well as its type, with a polyline. As indicated by the messages of the command line, the user marks the points enclosing the surface. At the point prior to the last, the user types “c” to close the polyline. The surface is enclosed in a polyline with blue color and a window indicating the rainwater surfaces types pops up.

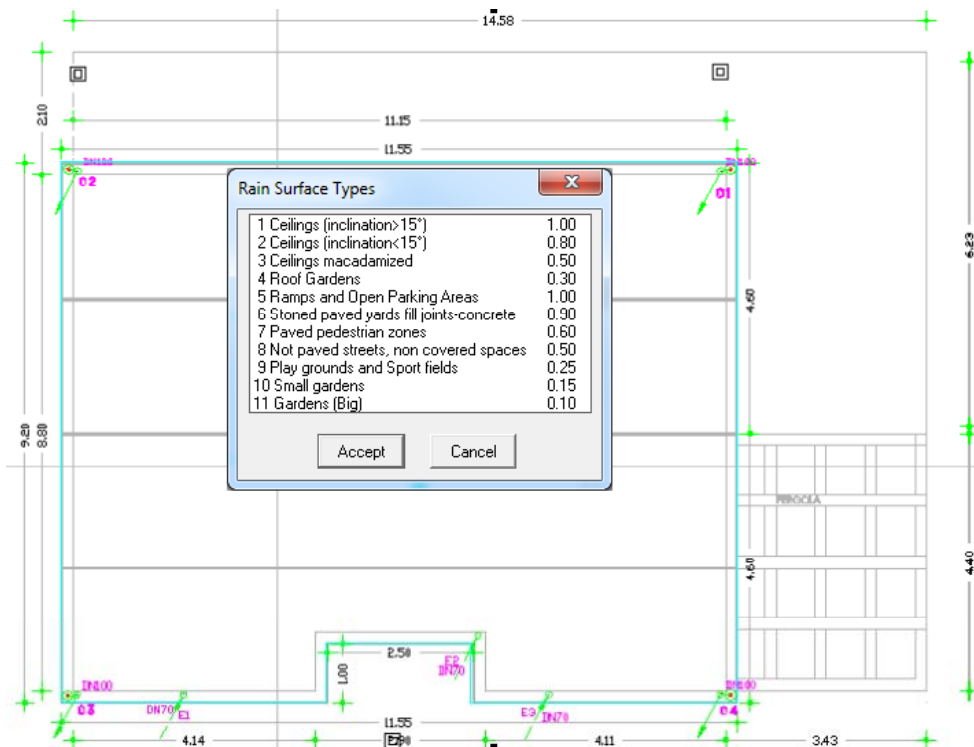

Once the type of surface is selected, the window closes and a sign indicating the characteristics of the surface is placed on the drawing. The specific characteristics will be transferred to the calculations sheet in order to assist to the calculation of the rainwater networks. In every surface, the drain pipes should be enclosed in order to enable the program to distribute the quantity. That is, if you place a drain pipe in a surface, this should take the whole area of the connected surface. In case of two drain pipes, each one will take half of the connected surface area.

Surface names reset: If the user wishes to modify the surface that absorbs the rain he / she must do it manually, as the sign is NOT updated automatically. He / she must delete the sign and select “Surface names reset”, in order to measure the area again.

This completes the set of actions needed for the recognition of the network.

Network recognition: Select “Network recognition”, in order the AutoNET to recognize the logic as well as the position of the receptors in the spaces and to prepare the files for the connection with the calculations. During the “recognition”, messages might warn the user for possible drawing errors, such as for instance that more than 2 pipes end up at a single receptors point of connection, there is a missing or wrong location of runoff, elements unconnected etc. Besides, checking the axonometric drawing, no “white colored” parts should appear upon our network, otherwise the program does not recognize those lines as parts of the network and they will not be taken into account for the calculations. The “Network Recognition” window refers to “Sewage” application, namely to the failure of recognition of the “Rainwater Surfaces”. If within the perimeter set by the user no runoff exists, the program points it out as an error and displays it on a separate window. This window displays data like the floor on which the surface is, the layer at which belongs to, etc.

Calculations: After the check you are read to go to the computing environment. By selecting the option “Calculations” in "AutoNet" menu the Sewage calculations program is displayed. Next, you can select the options “Files” and “Update from drawing”, and the data is transferred at the calculations sheet.

Update plan view: When the calculations in the program (ADAPT) are completed, you can store the project. You can refer to the drawing program (FINE) and select “Update plan views”. With this option the calculations regarding the piping are transferred to the plan view. If this action was already carried out earlier, the program will ask if the user wants to delete the previous update and replace it with the new one.

Other drawing actions – Completion of the drawings: When returning to the drawings, the user should not forget the designation of the ventilation shafts. This should be followed by the drawing of various elements of the network, like the trap door, caps, wells, mechanical siphon, etc. The drawings (pumps, general assemblies manufacturing details and so on) can be selected from the libraries of AutoNet, or through the “Sewage” toolbar and the corresponding icon. If there is a Pit instead of a central Sewage network this must be pointed out in the drawing of the plan view.

Vertical Chart: The vertical chart is created automatically with the use of FINE provided that the network was designed by this program. The way is similar to the one described above for the Water Supply Application. From the AutoNET menu you can select “Vertical chart” > “Create”. The following window appears on the screen:

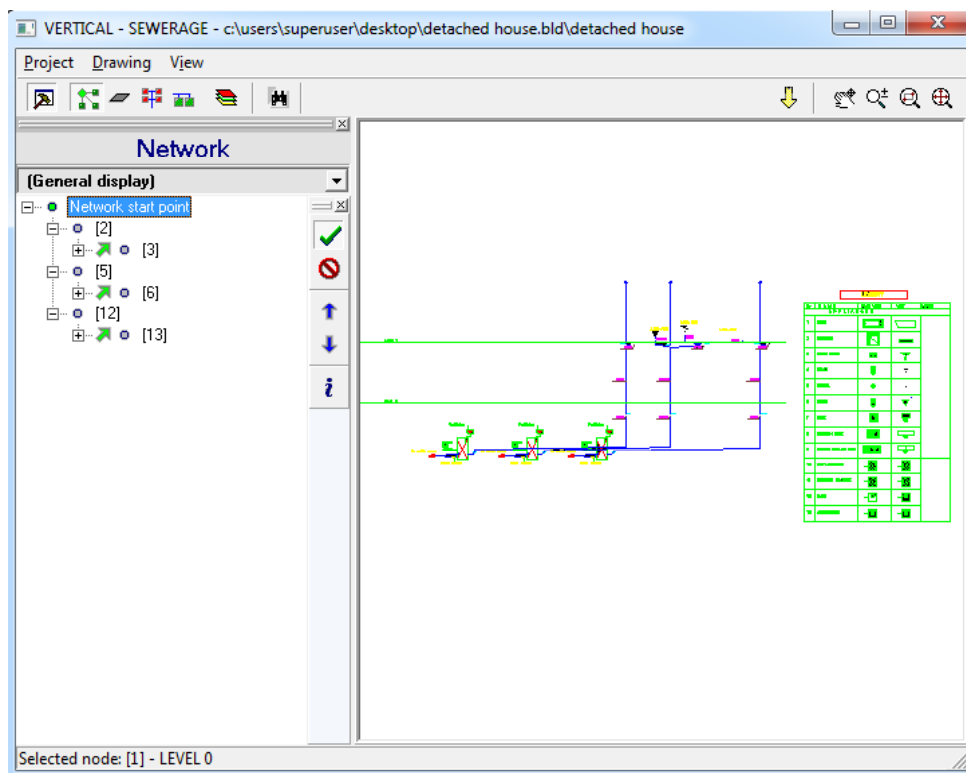

The user can apply all desired changes or close the window, which will result to the display of the drawing in a DWG form, which can modify using the CAD programs. Details regarding the function of the vertical chart maker can be found in section 4.13 of the present manual.

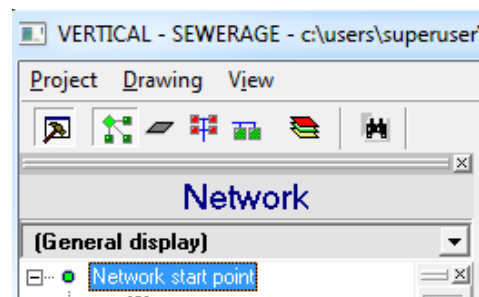

3. Calculations

3.1 Overview

This chapter provides a description of the Calculations Component of FineSANI. Each module can be used either independently, by filling the numeric data, or in co-operation with the CAD component of FineSANI, in which case the calculation environment acquires the data directly from the drawings.

At the top of the application window appear the general options of each application menu, constituted of the group options **"Files"**, **"Project Data"**, **"View"**, **"Windows"**, **"Libraries"** and **"Help"**.

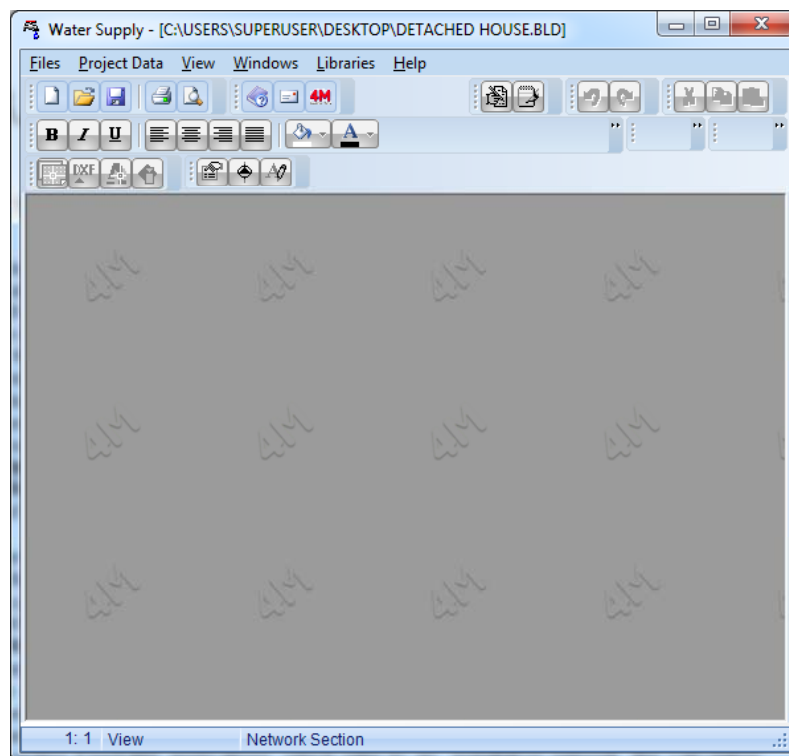

The execution of the calculations takes place in an **advanced calculation environment** especially designed by 4M for the particular needs of any specific application. It is a spreadsheet type environment with specific capabilities and facilities, tailor-made for each application. More specifically, regarding FineSANI applications which refer to an installation network, the calculation sheet is shown in a spreadsheet using lines corresponding to the network branches, and columns containing primary data (e.g. length) and results of calculations (e.g. water velocity) for each branch. An example of such a spreadsheet for the Water Supply Application is shown below:

Network Section	Pipe Length (m)	Type of Receptor	Receptor Capacity (l/s)	Peak Capacity (l/s)	Desired Pipe Size (mm)	Pipe Size (mm)	Max Velocity (m/s)	Water Velocity (m/s)	Type of Fittings	Fittings friction drop (m/WG)	Pipes friction drop (m/WG)	Total Friction Loss (m/WG)	Circuit Polar Angle	Parallel branch of Hot Water	Pressure Receptor (m/WG)
1	1.2	17.8	0.570	0.390		DN25	2	0.676	F-1	0.098	0.559	0.657			
2	2.3	3.2	0.150	0.150		DN15	2	0.755	F-2	0.055	0.251	0.306			10.00
3	2.4	3.4	0.130	0.130	21.5	DN20	2	0.368	F-2	0.012	0.045	0.057			10.00
4	2.5	3.3	0.070	0.070	21.5	DN20	2	0.193	F-2	0.004	0.014	0.018			10.00
5	2.6	13.1	0.150	0.150	21.5	DN20	2	0.413	F-2	0.017	0.224	0.240			10.00
6	2.7	2.6	0.070	0.070	21.5	DN20	2	0.193	F-2	0.004	0.011	0.015			10.00
7															
8															
9															
10															
11															
12															
13															
14															
15															
16	1-8	1.9	0.370	0.296		DN20	2	0.815	F-3	0.061	0.108	0.169			
17	8-3	3.4	0.150	0.150	21.5	DN20	2	0.413	F-2	0.017	0.052	0.069			10.00
18	8-6	12.9	0.150	0.150	21.5	DN20	2	0.413	F-2	0.017	0.198	0.214			10.00
19	8-7	2.4	0.070	0.070	21.5	DN20	2	0.193	F-2	0.004	0.009	0.012			10.00
20															

In order to make the network understandable by the program, a specific standardization should be followed, which is more or less the same in all applications. This standardization can be easily understood with the following simple example.

Suppose we have the network which is shown in the adjacent figure. This network comprises of several branches (i.e. parts of the network), junction points and terminals (end points). Thus in this network, we have assigned arbitrary numbers to both the junction points (1,2,3) and the hydraulic terminals (4,5,6). Each junction point may be assigned to a number (from 1 to 99), a letter (lower or upper case, e.g. A, d etc) or a combination of letters and numbers (e.g. A2, AB, eZ, 2C etc.). The main restriction is that the starting point is always assigned to the number 1. Also, assigning the same number to the same network twice is not permitted for obvious reasons, with the exception of the junction point 1 for which the assignment may be repeated as desired (for networks with more than one starting points). After numbering the junction points and the terminals according to the above rule and in order to represent the network in the spreadsheet, it is enough to give a name to the various sections of the network entered in the first column of the spreadsheet. Having in mind that the order of the network sections is not important, we fill in the first column with the two junction points of each section (putting a dot in between) so that the sequence of junction points matches the direction of the water flow in the pipe. In the above example the network sections will be shown as:

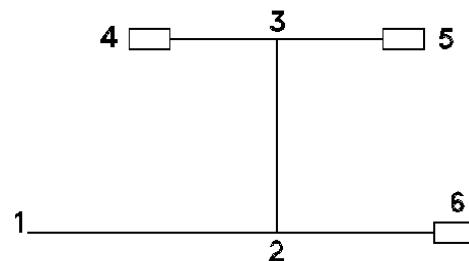

Network section
1.2
2.3
2.6
3.4
3.5

In the other columns of the row we fill in a series of data (e.g. length of section, accessories included in the section etc.) which depend on the type of the installation and the results are automatically generated (e.g. pipe size, fittings friction drop etc.) depending on the particular installation. Similar standardization, is also applied to the Sewage application.

Taking as a reference point the above spreadsheet we can see the **columns heading zone** (every column has its title and units), **the zone for filling in the values** with a number of rows (separated with dotted lines for better supervision and clarity) and a **status bar** (at the bottom of the window) where helpful information appear depending on the position in the spreadsheet we are in. Since the spreadsheet contains usually a lot of information and is the core of the calculations in each application, it is particularly useful to have it maximized on the screen by clicking on the upper arrow (located at top right of the window) so that the whole computer screen area is utilized. The next section will familiarise you with the “Calculation Sheet”, as the basic functions which are described are to a great extent common in every application.

The Calculation Sheet provides its user with all the editing functions, which are described below:

First of all, as stated before, the user can change in the "Font" for both the calculations zone (so that values appear with the desired size and style) and the headings zone (so that headings are shown to the user's satisfaction).

As far as the *headings zone* is concerned, the user has also the possibility to increase or decrease the column width using the mouse: as long as the mouse pointer rests on the vertical line separating two adjacent columns, it takes the form of a double arrow and then by pressing (and keeping pressed) the left mouse button and dragging it, the column width is increased or decreased depending on the direction of mouse movement. In the spread sheet below we can see that the columns have different widths:

Network Section	Pipe Length m	Type of Receptor	Receptor Capacity (l/s)	Peak Capacity (l/s)	Desired Pipe Size mm	Pipe Size mm	Max Velocity m/s	Water Velocity m/s	Type of Fittings	Fittings friction drop (mWG)	Pipes friction drop (mWG)	Total Friction Loss mWG	Circuit Polar Angle	Parallel branch of Hot Water	Pressure at Receptor mWG
1	1.2	17.8	0.570	0.390	DN25	2	0.676	0.676	F-1	0.098	0.559	0.657			
2	2.3	3.2	14	0.150	0.150	DN15	2	0.755	F-2	0.055	0.251	0.306			10.00
3	2.4	3.4	20	0.130	0.130	DN15	2	0.655	F-2	0.042	0.204	0.246			10.00
4	2.5	3.3	29	0.070	0.070	DN15	2	0.353	F-2	0.012	0.063	0.075			10.00
5	2.6	13.1	2	0.150	0.150	DN15	2	0.755	F-2	0.055	1.028	1.083			10.00
6	2.7	2.6	7	0.070	0.070	DN15	2	0.353	F-2	0.012	0.050	0.062			10.00
7															
8															
9															

Alternative supervision possibilities are available to the user depending on several factors such as the resolution of the graphics card and the screen size, and for this reason any possible interventions are left to the user's discretion. For that matter, there is also the possibility of “Load Prototype” from the user (from the Files > Load Prototypes menu). Note however, that the best supervision results are achieved with higher resolutions and large screens.

The user can fill each cell either by double clicking on it with his mouse or by using the arrow keys of the keyboard. The columns which contain the calculation results (such as the *pipe size* or the *water velocity*) cannot be modified unless there is a “desired” column (such as the *desired pipe size* where the user can choose a different pipe size and the results are automatically updated).

If we move the mouse pointer (having the form of a cross) to a cell or small square and click the left mouse button, we'll see that the cell contour (outline) becomes dark and we can fill in a value or modify the cell content. In the same way we can move to any other cell, or use the <Enter> key to move to the next cell below, the <Tab> key to move to the next cell at the right and so on.

In case the window width is not large enough to accommodate all columns, we can review the entire calculation sheet by moving up-down or left-right between the cells using the vertically or horizontally sliding keys.

The user should keep in mind the following useful commands when **entering values** in the Calculation Sheet of any application:

Deleting cell content: By pressing the key on a cell, its value is deleted and the cell becomes blank.

Deleting a row: By pressing the keys <Ctrl>& in combination, the row we are in is deleted.

Inserting a row: By pressing the keys <Ctrl>&<Ins> in combination, a new (blank) row is inserted immediately below the cell we are in.

Moving to the beginning of a row: By pressing the <Home> key we move automatically in the first column of the row we are in.

Moving to the end of a row: By pressing the <End> key we move automatically in the last column of the row we are in.

Moving to the upper part of the sheet (first column-first row): By pressing the keys <Ctrl>&<PgUp> in combination, we automatically move in the first column-first row of the calculation sheet.

Moving to the lower part of the sheet (first column-last row): By pressing the keys <Ctrl>&<PgDn> in combination, we automatically move in the last row of the calculation sheet.

Finally, you can move **from an upper to a lower cell using the <Enter> key** and from a **left cell to a right cell using the <Tab> key**.

In addition, the calculation sheet provides to the user a **set of Spreadsheet Functions, which are available in most windows applications**, such as the Cut-Copy-Paste type of commands of a subset of lines (or even the whole calculation sheet), the row and columns width definition, the font type (as well as font attributes, justification etc.) of a selected area, and so on. By selecting a certain area of the spreadsheet (or all of it by “select all”) and then pressing the right button of the mouse, a small menu appears on screen, with the relative commands. Another useful command is the Undo/Redo command concerning the calculations. All those editing commands are also applied to other windows. Apart from the copy-paste command, in case we want to repeat a row (typical branch), it is sufficient to fill in the content of the first column, i.e. the section name, that will make a copy of the row except for the section name which remains blank. When the calculation sheet is activated, you will see in the main menu the additional option “Calculation Sheet” with a secondary option “Printing Parameters”. Selecting “Printing Parameters” the adjacent dialog box appears and from there the user can change the appearance of the printed Calculation Sheet. Specifically, the user can define a bold outline (frame), a normal outline, or no outline, horizontal and/or vertical lines, as well as a raster for the titles (headings) of the spreadsheet with the desired shading of tints (using the sliding key). As previously emphasised, the Calculation Sheet window is the core for all applications. Since, however, not all calculation results related to a study can be confined within the Calculation Sheet, every application has additional windows where these complementary results are accommodated to form the complete set of the study. The functional description of these windows is the subject matter of each application.

For all that, we can pick out, among the available windows, some of them with common philosophy regardless of application (e.g. “Bill of Material – Costing” Window, “Technical Description” Window etc.). The “forms” of these windows are described in the following sections.

3.2 Water Supply

If you want the Water Supply System application to be executed, point with the mouse and double click on the relevant icon, and the main menu window will appear:

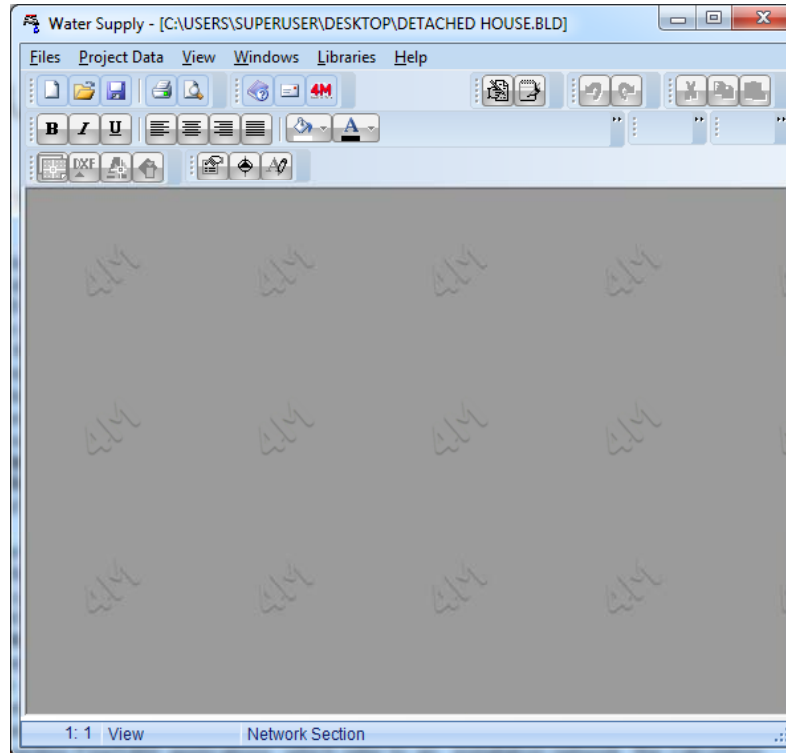

As you can see, the basic menu options are divided into the groups "**Files**", "**Project Data**", "**View**", "**Windows**", "**Libraries**" and "**Help**", and are described below along with their secondary options.

3.2.1 Files

The "Files" option includes the usual file management options according to the windows standards:

New project: Type a name for the new project you want to be saved in a file (in case you haven't started the project from FINE SANI).

Select project: A window appears where you can select the desired (existing) project file and load it.

Caution! *If neither a new nor an existing project is selected, the programme automatically considers that the UNNAMED project is active. If you add new data to the UNNAMED project and you want to save it with a different name, select "Save as" and type the new project name.*

Update from Drawing: This step is very important in case of co-operation with FINE SANI, as with this command the project *calculation sheet* is updated with the drawing data.

Caution! *If the option "Update from Drawing" is selected without previously opening a project and inserting data in the ground-plans using the FINE SANI, any existing data in the calculation sheets will be replaced with blanks.*

Save: The project you are currently working on is saved to the hard disc (with the previously given name).

Save as: The project you are currently working on is saved in a different file with a new name.

Load Prototype: The saved prototype appears on the screen.

Save as Prototype: The user has the choice to save the form he has created and is displayed on the screen as Prototype so as to be able to use it again.

Printing Prototypes: The printing prototype management window is activated.

Print: The project issue is printed according to the previously selected options in "Printing Contents" and "Printing Parameters" as well as according to the print preview output.

Printing Contents: You can select the Water Supply System project items you want to be printed.

Printing Parameters: The desired printing parameters can be selected in this window.

Print Preview: The complete project issue appears on the screen, exactly as it will be printed, page to page.

Export to RTF file: An rtf. file containing the project items, is created (within the project directory, with the name YDRE.RTF).

Link to WORD: An rtf. file, containing the project items, is created (within the project directory, with the name YDRE.DOC). At the same time, the MS-Word application is activated (if it is installed in your PC).

Link to 4M editor: An rtf. file, containing the project items, is created (within the project directory, with the name YDRE.RTF). At the same time, the 4M text editor is activated for further editing.

Link to EXCEL: An excel file, containing the project items, is created (within the project directory, with the name YDRE.XLS). At the same time, the MS-Word application is activated (if it is installed in your PC).

Export to PDF: A pdf file containing the project items, is created (within the project directory, with the name YDRE.PDF). At the same time, the Acrobat Reader application is activated (if it is installed in your PC).

Exit: Exit from the application.

3.2.2 Project Data

The basic project data, are divided into **Project info** (project headings) and **Network** data. The "*Project info*" data refer to titles and headings related to the project identity while the option "*Network*" data refers to the general network data that the project designer should specify and are related to:

Parameter	Value
Water Temperature (°C)	10
Type of Building	Apartment
Main Pipe Type	Seamless steel pipe
Main Pipe Roughness Factor (im)	150
Secondary Pipe Type	Cooper pipe
Secondary Pipe Roughness Factor	1.5
Max Water Velocity (m/s)	2
Friction Limit per meter Length of Piping (mwg/m)	0.1
Import data from the Vertical Diagram	<input type="checkbox"/>

Water temperature (°C): The cold water inlet temperature value is filled in and the relevant viscosity is taken automatically into account for the calculations. It should be noted that, for the hot water a temperature difference of 50°C is taken into consideration. If only the cold water supply network is specified through the program and the water temperature is higher than 40°C, the program automatically considers that the calculations that are carried out concern the hot water network which corresponds to the specified network, ignoring the receptors without hot water and taking into consideration the hot water viscosity for the calculations. With this possibility you can calculate quickly the cold and hot water networks at the same time.

Type of building: According to one of the cases "apartment", "office", "hotel", "store", "hospital" or "no coincidence", the relevant coincidence curve is taken into consideration.

Main pipe type: With the key <F11> or by pressing the key in the field, you can select from the pipe library window that appears the pipe type which shall be used in the project (e.g. Copper pipe).

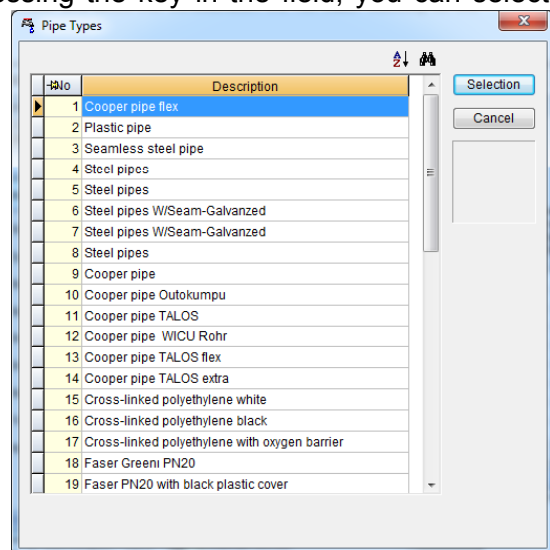

Main pipe roughness factor: The above selected pipe roughness appears automatically in (µm), which can be modified if the user wishes to.

Secondary pipe type: You can select the secondary pipe type, if of course a second pipe type is used in the project (for example you may have copper pipes as the main pipe type in the columns, and a plastic infloor pipe as a secondary pipe type for the connections with the receptors).

Secondary pipe roughness factor: The secondary pipe roughness appears in (µm) accordingly.

Max water velocity: It is the maximum water velocity based on which the cross-sections are calculated. That is to say that the smallest possible cross-section (for which the velocity does not exceed this value) shall be selected. This value can be modified here as a whole by the designer (and it shall be applicable in every part of the network), and also within the calculations sheet, in selective parts (*It is suggested that the velocity should not exceed the 2-3 meters*).

Friction limit per meter length of piping: According to the above mentioned velocity, there is a friction limit which is used for the calculation of the cross-sections. Here for example, the smallest possible cross-section is selected, for which the friction value does not exceed the specified friction limit.

Import data from the Vertical Diagram: This option enables you to draw the vertical chart firstly with the aid of an expert system and thereafter to transfer the data in the calculation sheet. If the check box is checked, the option "Insert vertical" appears in the program menu and you can use it in order to draw the vertical chart. This option is used in case the user hasn't started the project from FINE SANI and it is described in detail in the next paragraph.

3.2.3 Import data from the Vertical Diagram

This option enables the "Draw vertical diagram" tab in which the "Vertical diagram creation" and the "Update from vertical diagram" options are included. They are explained in the following sections.

3.2.3.1 Vertical Diagram Creation

This option has the following secondary options:

1. Diagram type

Here the user can specify the general topology of the vertical diagram that he is going to draw. In particular, the following options appear:

- **Cold water network > Water supply**

Here it is specified whether the cold water supply is separate in each apartment (e.g. Apartment block) or central (e.g. Hotel rooms).

- **Hot water network > Water supply**

Here it is specified whether the hot water supply is separate in each apartment (e.g. Water heater in each apartment) or central (e.g. Central boiler).

- **Network type > Building water network**

Here you can select the pipe type that shall be used in the central network of the building. The program offers the possibility to calculate a network with two different pipe types. If you select “Primary” the selected pipe type will be used as the primary in the “Network data” otherwise the secondary pipe will be used.

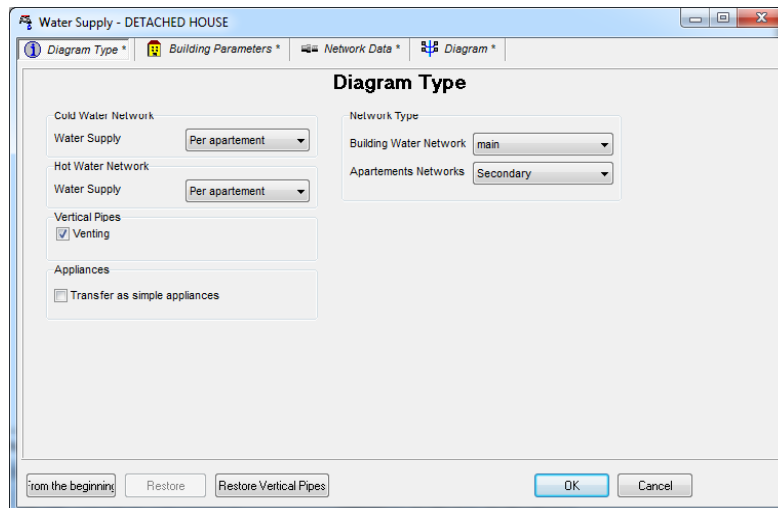

- **Network type > Apartment networks**

You can select “Primary” or “Secondary” depending on the previous option.

- **Vertical pipes > Venting**

It is specified whether the vertical columns will appear in the vertical chart with or without ventilation.

- **Appliances > Transfer as simple appliances**

It is specified whether each receptor is defined separately in the vertical chart or if it will be integrated in a receptor group. In case that the check box is checked, the network is analysed thoroughly in nodes.

2. Building parameters

If you select the *Building* in the upper left part of the screen, the building data will appear.

The topology of the building as well as the layout of the installation network in it are included in the building parameters. There are two distinct secondary options:

A. Building options

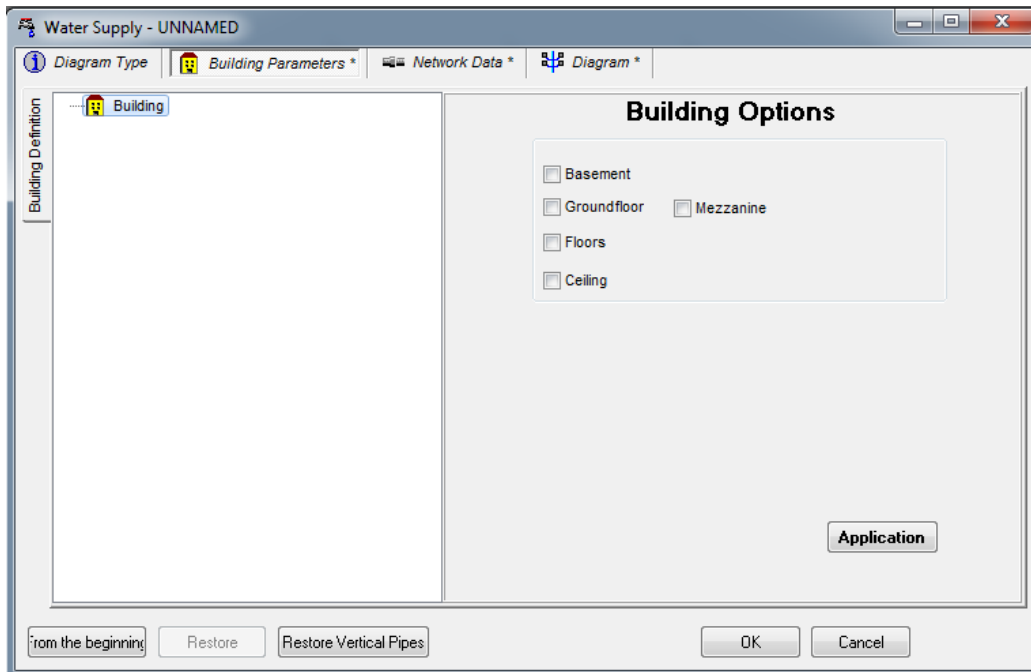

Here the levels (floors) which constitute the building, are defined. In particular, if you select the Basement and the Floors, an additional field will appear where the user should fill in their number. You can also define the number of the apartments in each floor as well as the height of each floor.

After the user has defined the building data, he can press the key “Application” and the building will appear in the left column in a tree form with an icon in front of it that shows the floor type.

Working with levels

If you click with the left mouse key on the level name, the level data “Level Name”, “Level Height (m)” and “Number of Apartments” appear on the right side. The user can enter the fields “Level Name” and “Level Height (m)” and edit the level data.

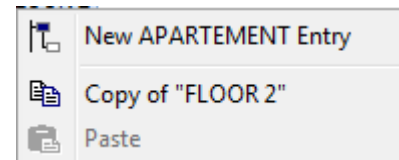

If you double click with the left mouse key on the level name, the floor topology with the apartments will appear in tree form.

If you click with the right mouse key on the floor name, a menu with the following options will appear:

- **New Apartment entry:** You can insert a new apartment besides the ones that are defined so far.
- **Copy of FLOOR:** The command copies the floor network in order to paste it later on a different floor.
- **Paste FLOOR:** Pastes the network data that are saved in the clipboard to the selected floor. The data that are already entered in the floor shall be overwritten by the new data.

Working with apartments

If you double click on the floor the apartments will appear and in the right side the option “Insert space with water supply” will appear, where a list with various space types will be shown. If you double click on each space, its drawing will appear underneath it. If you double click on the desired space, this will be transferred automatically in the apartment selected in the left column. In the same way you can add more spaces in the same apartment or in different ones.

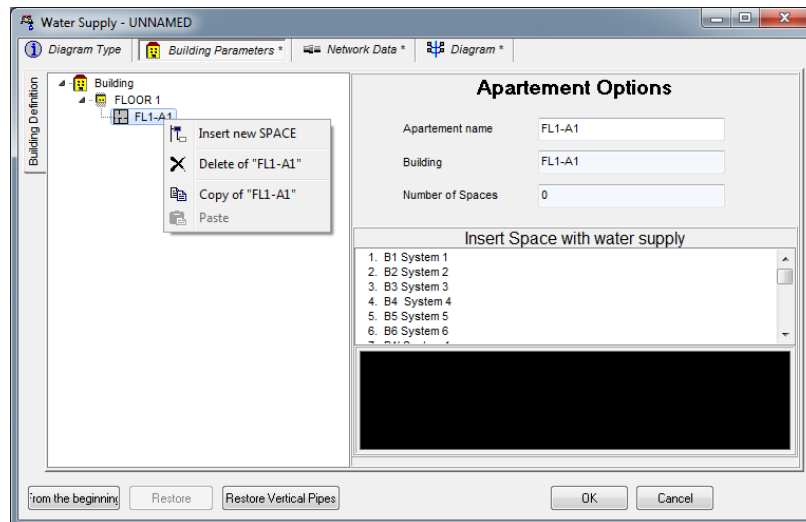

If you right click on an apartment space the list shown in the next window will appear, with which you can manage the spaces:

- The command “Delete”, deletes the space.
- The command “Move upwards”, moves the space upwards.
- The command “Move downwards”, moves the space downwards.
- The command “Move to previous level”, moves the space to the previous level.
- The command “Move to next level”, moves the space to the next level.

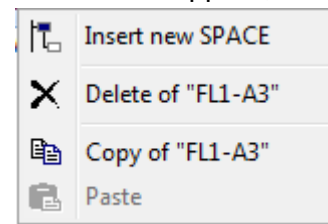

3. Network data

In this tab you can set the network structure from the water supply until each apartment.

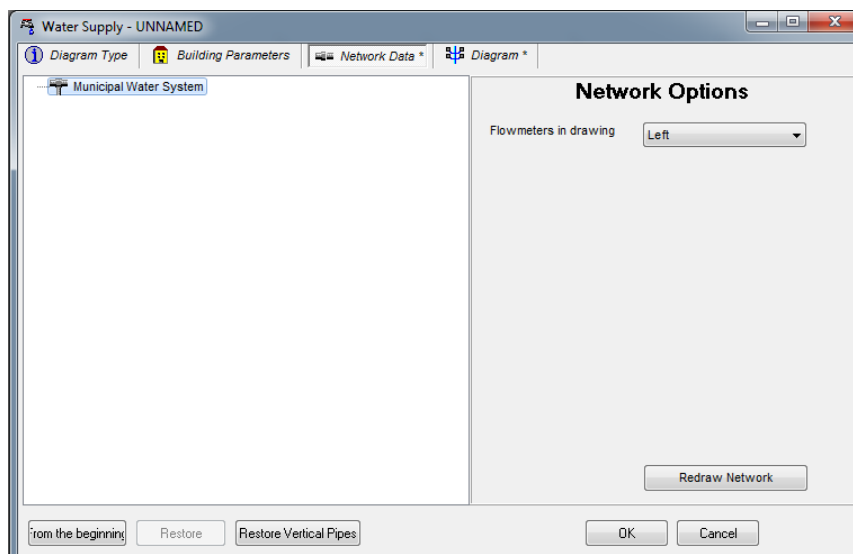

In this option, the user can manage the water supply systems. At first, there is a separate water supply system for each apartment. If for example, there are two apartments in the building with common ownership which are located in different floors, then the user can transfer the water supply from a column to a different one, delete a column or a certain flow gauge. This is achieved by right clicking on an element. Depending on the "tree" element on the left side of the window that you right click, a menu appears which enables you to move or delete or even add an element. Hence, the user is able to modify the network as it is desired.

4. Diagram

With this option, the vertical diagram of the previously mentioned installation appears. The user can change the colors that appear in the chart and disable several network information.

Apart from that, with the option *Drawing Distances* he can define the distances between the lines in order to acquire a better view of the diagram.

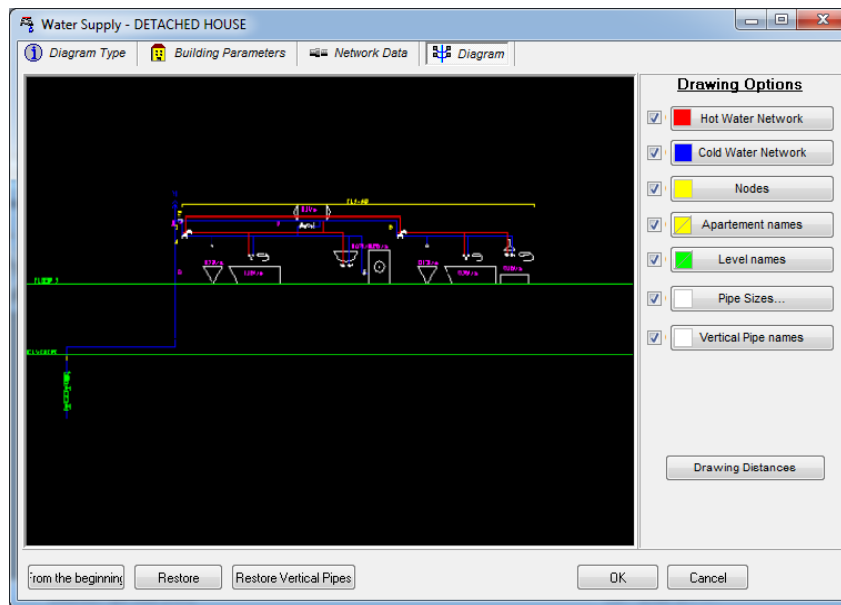

3.2.3.2 Update from vertical diagram

This command is used to transfer the network data of the vertical diagram in the "Calculation sheet".

3.2.4 View

This option includes the secondary option "Toolbars" and follows in general the windows standards.

3.2.5 Windows

The "Windows" option includes a series of calculation and result windows, in which the detailed project calculations are presented. The main window which comprises the core of the application calculations is the Calculation Sheet, and it is described in the following paragraphs.

3.2.5.1 Cover Page

The "Cover page" window is the first printed page of the project and the program enables the user to select among different types of cover pages, or even create his own cover page, exactly as he wants it.

Note: The cover page files are stored in FINE11_SANI\CALC\Ydre, named YDRECV01.RTF; the description is stored in the file YDRECV.LST.

3.2.5.2 Assumptions

The text of the project general assumptions, which may be included in the printed project as long as it is selected in "Printing Contents", is stated. If the option "Assumptions" is selected, the option "Assumptions" with the secondary option "Select Prototype" appear in the menu.

3.2.5.3 System of appliances

Here the appliances systems that are used in the specific project are presented and analysed in the receptors constituting them.

3.2.5.4 Hydraulic Receptors Legend

The receptors that are used in the project are presented.

3.2.5.5 Calculation Sheet

The Calculation Sheet is the core of the calculations and conforms to the general rules of the Network Calculation Sheets, which are described in the first section. Therefore, each row of this sheet corresponds to a different network section while each column refers to the data that will be filled-in or will be calculated automatically during the procedure of data completion. Help instructions concerning data entering appear at the bottom of the screen (status bar). First of all, in each row the fields of the first column (which refer to section designations) should be filled-in.

The method for the network standardisation is based exactly on the standardisation rules that were explained earlier. Here is a short description of the columns of the calculation sheet:

Network Section	Pipe Length (m)	Type of Receptor	Receptor Capacity (l/s)	Peak Capacity (l/s)	Desired Pipe Size (mm)	Pipe Size (mm)	Max Velocity (m/s)	Water Velocity (m/s)	Type of Fittings	Fittings friction drop (mWG)	Pipes friction drop (mWG)	Total Friction Loss (mWG)	Circuit Polar Angle	Parallel branch of Hot Water	Pressure (mWG)
1	1.2	17.8	0.570	0.390	DN25	2	0.676	F-1	0.098	0.559	0.657				
2	2.3	3.2	14	0.150	0.150	DN15	2	0.755	F-2	0.055	0.251	0.306			10.00
3	2.4	3.4	20	0.130	0.130	DN15	2	0.655	F-2	0.042	0.204	0.246			10.00
4	2.5	3.3	29	0.070	0.070	DN15	2	0.353	F-2	0.012	0.063	0.075			10.00
5	2.6	13.1	2	0.150	0.150	DN15	2	0.755	F-2	0.055	1.028	1.083			10.00
6	2.7	2.6	7	0.070	0.070	DN15	2	0.353	F-2	0.012	0.050	0.062			10.00
7															
8															
9															

1. Network section: In the rows of the first column you should fill in all the network sections (one section in each row) one by one. For the better organisation and supervision it is recommended to fill in the sections of the cold water network at first, following by the sections of the hot water network. The sections are defined by their end nodes. You may assign a number (from 1 to 9999) or a letter (lower or upper case, e.g. A2, AB, 3c, Aa etc.) to each node. The basic restriction in numbering is that number 1 is always assigned to the point that is connected to the gauge, while number 1 is also assigned to each water heater.

Except the number "1", the same number should not appear in the network twice. After the numbering you can enter in the calculation sheet all the sections independently one by one (the sequence of the sections is not important), by filling in the first column:

- **For the cold water network:** The two nodes of each section with a dot in-between (".") and with the same direction as the water flows (e.g. if the cold water flow is directed from the node 3 towards node 4, then you should fill in "3.4").
- **For the hot water network:** The two nodes of each section with a dash in-between ("-") and with the same direction as the water flows (e.g. if the hot water flow is directed from the node 2 towards the node 4, then you should fill in "2-4"). The numbering of the receptors is the same with the one of the cold water network. For example, if you assign the number 5 to a receptor for the cold water, you have to assign the number 5 to the same receptor for the hot water.
- **For the recirculation network:** An additional possibility that the program offers is to calculate the piping for the hot water recirculation. The user defines the route(s) for recirculation from the point 1 up to the most remote node of recirculation by filling in the figure 1 and the number of the node and inserting the symbol "+" (e.g. 1+80). Next he enters the recirculation distance from 1 up to the remote node, the required capacity is calculated automatically and after that the pipe cross section is calculated.

In the case of typical (similar) sections it is possible to recall them (with their name from the first column) in order to automatically transfer them.

2. Pipe length: You must state the pipe length in (m) in every section between two nodes (e.g. section 2.3).

3. Type of receptor: If there is a receptor (appliance) at the specific network section, that is to say if the section ends up to a receptor, you can select a receptor from the library with the water supply network receptors, after pressing the key **F11** or by pressing the key inside the field in this column. A window will appear with the list of the receptors. The type of the appliance (hydraulic receptor) is defined when a unit is filled in the last column, in the row that corresponds to the receptor, and the key "enter" is pressed after that in order to validate the data entered. By pressing "OK" you can return to the calculation sheet in column 6 where you can notice that the order number of the receptor is filled in. Alternatively, except defining only one receptor, you can also define a receptor group (Receptor System) with up to 10 different types of receptors in each section. Since you are working with receptor groups, the program enables the user to define an order number of the hydraulic receptors system *i* in the upper part (*System No*), and the relevant receptor System appears in the sixth column of the Calculation Sheet with the form S-*i*, where *i* represents the order number of the defined System. With this feature you avoid filling in again the same hydraulic receptors, since you can fill in directly the order number of the System in column 6 where the receptors are defined. The method with receptor systems is indicated in the case of very large installations, where the cases are grouped in a few systems and the data volume is radically decreased in the calculation sheet.

No	Name	In.Dia	Pmf	Qrcw	Qrhw	
1	Kitchen sink -inflow v2	13	10	0.15	0.15	
2	Kitchen sink - kitchen	13	10	0.15	0.15	
3	Kitchen sink - kitchen	13	10	0.07	0.1	
4	Kitchen sink - kitchen	20	10	0.20	0.70	
5	Kitchen sink - diverter	20	12	1	0	
6	Wash basin - outflow	13	10	0.07	0	
7	Wash basin - bath mix	13	10	0.07	0.07	
8	Wash basin - bath mix	13	10	0.05	0.05	
9	Shower - bath mixer	13	10	0.05	0.05	
10	Shower - bath mixer	13	10	0.15	0.15	
11	Shower - bath mixer	20	10	0.2	0.2	
12	Shower - bath mixer	25	10	0.35	0.35	
13	Shower - bath mixer	13	10	0.15	0.15	
14	Bath - bath mixer	13	10	0.15	0.15	
15	Bath - bath mixer	20	10	0.5	0.5	

4. Receptor capacity: The receptor capacity Q_R , or in general the network section capacity (theoretical sum of the capacities if all the receptors work at the same time) is automatically calculated. The program calculates automatically the capacity for the intermediate sections based on the capacity of the receptors that are supplied from this section.

5. Peak capacity: The peak capacity Q_s is calculated based on the total capacity of the previous column. The peak capacity is calculated from the relevant peak curve that depends on the "Type of building" which is defined in the "Network" (Project data > Network).

6. Desired pipe size: From this column the user can select a different diameter from the one that is calculated by the program (and is shown in the next column). If you press **F11** or the key in the field, the list with the diameters of the selected in the "Network" pipe type is shown.

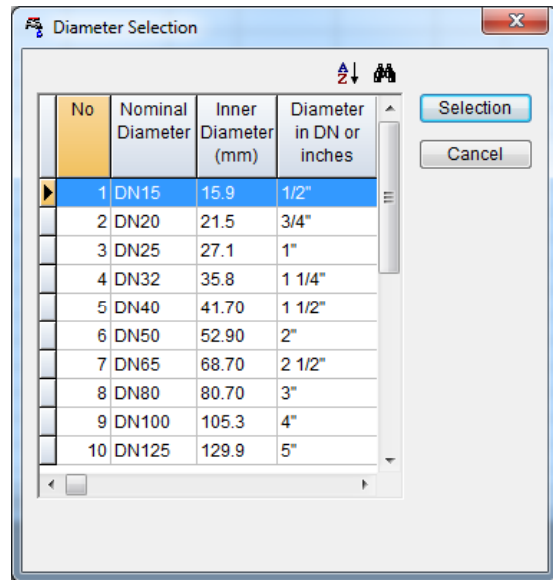

With the option "Selection" you can select the desired diameter, and the user can see the effects of his choice in the rest of the network parameters (e.g. velocity, friction values etc). If you press in the relevant component of the calculation sheet you can delete the selected diameter, and the program calculates again the diameter.

7. Pipe size: The pipe diameter of the network section as it is calculated by the program, is shown in this column.

8. Max velocity: The velocity limit that is defined in the "Network" in (m/s) is shown here. The user can easily modify it if he wants for the particular network section a different velocity limit. You should have in mind that, if you change later the general limit in the "Network" this will not affect the modified values but only the initial ones (the ones that have the same value with the "Maximum water velocity" which is defined in the "Network").

9. Water velocity: The water velocity in (m/s) as it is calculated in the specific network section, is shown here.

10. Type of fittings: This column refers to the type of fittings (elbows, tee sections, valves etc.) that appear in each network section. If you want to fill in the fittings in detail the user can press **F11** or the key in the field in this column, and the window with the list of the water supply system components from the relevant library will appear. If only one component exists, this is defined by writing the number 1 in the last column, in the row that corresponds to the component. By pressing "OK" the user returns to the calculations sheet in column 10 where he can notice that the order number of the defined component is filled in. For more than one components the user can fill in correspondingly the last column of the table with components, giving also the quantities of each component (up to 10 different types of components per section).

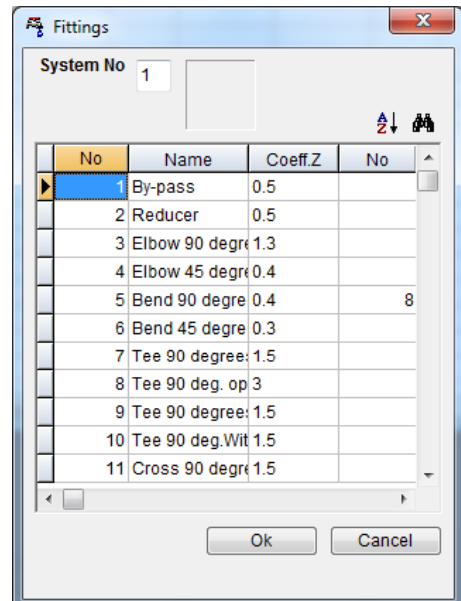

In the case that there are more than one components, in the column 10 of the calculation sheet the indication F- appears, which means in general "Fittings". If, in the upper part of the component table, you define a component system number (for example 3), in column 10 of the calculations sheet the indication E-3 will appear. In this way you can group the components and also avoid filling in the same groups (systems), since in column 10 where the components are defined the user can fill in directly the System number.

11. Fittings friction drop: The calculated fittings friction value for the specific network section in MWC (meters of water column) is shown here.

12. Pipes friction drop: The calculated friction value for the piping in the specific network section in MWC (meters of water column) is shown here. This friction is calculated from the water flow in the said section, based on hydraulic calculations.

13. Total friction loss: The total friction in the section, that is to say the sum of the friction of fittings and the friction of piping, also in MWC, is shown here.

Following the user will see the items "Circuit polar angle", "Parallel Branch of Hot Water", "Pressure of Receptor" etc. These items can be filled in directly in the relevant columns or from an additional window, which appears when you press the key F12 in any column (or if you press the right mouse button and select from the list "Options"). The use of these items is explained below:

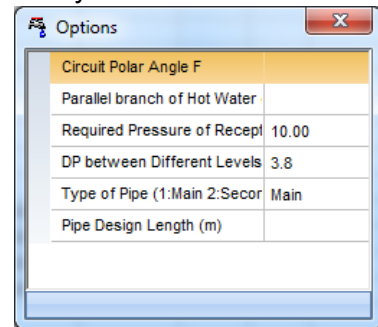

14. Circuit polar angle: It is necessary to fill in the polar angle of each network section only in the case that you desire to draw a vertical chart (and a network drawing) from the calculation sheet, that is to say in the case that you have not drawn the plan views in FINE SANI. The vertical diagram that is drawn takes into account the length and the polar angle (in relation to the horizontal axis) of each branch.

15. Parallel Branch of Hot Water: If you want to show also the branch of hot water in the vertical diagram, you should fill in correspondingly the sections which have a hot water branch. This work is necessary only in the case that you want to draw a vertical diagram (and a network drawing) from the calculation sheet with the polar angles, that is to say in the case that you have not drawn the plan views in FINE SANI or you have not drawn the vertical diagram with the option "Insert vertical chart" (Project data > Network).

16. Pressure of Receptor: Here you have to fill in the required pressure of the receptor which must be at least equal to the minimum discharge pressure of the receptor. The above mentioned pressure is filled in only in the case that you have given a direct flow or a receptor system, since in the case that you select a receptor from the library the discharge pressure is filled in automatically.

17. DP between Different Levels: Here the user fills in the Pressure Difference due to the receptor level elevation (positive or negative values), in meters of water column. This is the elevation from the supply point up to the receptor. **This is provided only in the sections with receptors and not in the intermediate sections.**

18. Type of pipe: If you use a second pipe type in the specific project (secondary pipe in "Network") then you will have to fill in the relevant data here.

19. Recirculation pump: In case there is a recirculation pump in the network section, the user chooses "YES" from the list so as to be taken into account.

20. DP recirculation pump: If there is a recirculation pump, the program calculates automatically the Pressure Difference.

21. Dh recirculation: In case of recirculation, in this column the user fills in the elevation difference in the recirculation line.

22. Pipe design length: Sometimes, when drawing a vertical diagram, you may design very short or very long sections. For that reason, the user may define an arbitrary pipe length in this column, which results to the desired **aesthetical** aspect in his design. Regardless of the length that the user defines in this field, the program shall write the **real pipe length** on the drawing. It should be pointed out that in case the user does not fill in this field, the program shall draw the vertical diagram based on the second column of the "Calculation Sheet", that is to say the "Pipe Length".

If you conform with the above standardization and you fill in the data for all the network sections, then the capacities in the sections without receptors are summed and are presented automatically in the column for the capacity. Based on the peak capacity in each network section and given the maximum velocity that corresponds to this section, the cross-section of the section pipe is established. Despite all this, the designer may give another standardised diameter, by pressing F11 from the sixth column or pressing the relevant key in the field and selecting from the list of standardised diameters from the library that appears on the screen. In whatever way the section has been defined, the effective water velocity and the pressure drops (see respective columns) of the piping and fittings in the respective section of the network will be exactly calculated.

Fixed column: Moreover, through the "Calculation Sheet" menu, the user can select the "Fixed Column" so that the first column of the sheet "freezes" on the screen. Thus, as the user fills in the fields of the sheet and is "led" towards the right, he knows exactly on which network section he is working on anytime. When the "Fixed Column" option is active, a yellow point (pin) appears at the bottom of the "frozen" field.

Example: Lets suppose that you have a simple water supply system that is shown in the following figure. Your first job is to assign a number to each branch (cold and hot water supply network) and receptors, according to the standardisation method described above. Thus, you can assign the number "1" to the network meter gauge (point of cold water supply). Moreover, you can assign the number "1" to the point of hot water supply to the water heater.

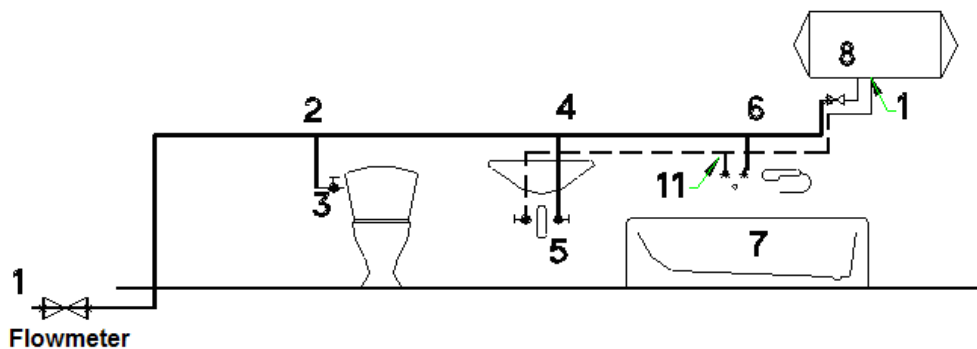

When you will assign the numbers to the cold and hot water supply networks as it is shown in the figure, you can fill in the network sections (with their lengths and their receptors, if available) in the calculation sheet, as it is shown below:

Network Section	Pipe Length m	Type of Receptor	Receptor Capacity (l/s)	Peak Capacity (l/s)	Desired Pipe Size mm	Pipe Size mm	Max Velocity m/s	Water Velocity m/s	Type of Fittings	Fittings friction drop (mWG)	Pipes friction drop (mWG)	Total Friction Loss mWG	Circuit Polar Angle	Parallel branch of Hot Water	Pressure of Receptor mWG	DP due to Different Height (mWG)	Type of Pipe	Recirculation Pump
1	1.2	17.8		0.420	0.322	DN20	2	0.887			1.269	1.269					Main	
2	2.3	3.2	20	0.130	0.130	DN15	2	0.655			0.192	0.192			10.00		Main	
3	2.4	3.4		0.290	0.251	DN20	2	0.691			0.151	0.151					Main	
4	4.5	3.3	7	0.070	0.070	DN15	2	0.353			0.063	0.063			10.00		Main	
5	4.6	13.1		0.220	0.205	DN20	2	0.565			0.399	0.399					Main	
6	6.7	2.6	14	0.150	0.150	DN15	2	0.755			0.204	0.204			10.00		Main	
7	6.8	3	29	0.070	0.070	DN15	2	0.353			0.057	0.057			10.00		Main	
8																		
9	1-11	1.9		0.220	0.205	DN20	2	0.565			0.053	0.053					Main	
10	11-5	2		0.070	0.070	DN15	2	0.353			0.034	0.034			10.00		Main	
11	11-7	3.2		0.150	0.150	DN15	2	0.755			0.233	0.233			10.00		Main	
12																		
13																		
14																		
15																		
16																		
17																		
18																		

3.2.5.6 Pressure Vessel

With this option the user can select a pressure vessel with initial air pressure (mainly in large assemblies) after completing the cells which appear on the screen (the cells in red are the results).

3.2.5.7 Pressure Vessel with membrane

With this option the user can select a simple pressure vessel with membrane, after completing the cells which appear on the screen (the cells in red are the results).

3.2.5.8 Network Drawing

The numbered network drawing is shown on the screen, provided that polar coordinates have been inserted in every network branch (see calculation sheet).

3.2.5.9 Vertical Diagram

If the user wants to create a vertical diagram using the calculation sheet (and not automatically, using FINE SANI), the above option creates the vertical diagram provided that the polar coordinates have been inserted in every network branch.

It is pointed out that it is possible to select a drawing for the engine room from the menu "Vertical diagram".

3.2.5.10 Sections friction drop

In this window the user views the total frictions in all branches (or routes), starting from the gauge and ending in each terminal node. Moreover, for more convenience, the most unfavorable branch appears in the bottom of the window.

3.2.5.11 Bill of Materials - Costing

The bill of materials-cost estimation results regarding the specific project are presented. The user can edit the bill of materials sheet, modify costs or quantities, insert discounts, and add jobs or materials.

3.2.5.12 Detailed bill of materials

In the *Detailed bill of materials* window the user can see the quantities of each material analytically and make his own additions.

3.2.5.13 Technical Description

The window “Technical Description” supports the creation of the project technical description, enabling the user to select among various technical description prototypes and text editing styles.

3.2.6 Libraries

The Water supply Libraries comprise the following material categories, with their respective features:

- **Water supply network components**, with specified characteristics (resistance, life circle, cost)
- **Pipes** (pipe types) with a given roughness, standardization (nominal, internal diameter) and cost.
- **Full-featured water supply receptors** (minimum connection diameter minimum discharge pressure, cold water supply, hot water supply).
- **Pressure blocks**, with all their features and their performance.
- **Receptors systems**: The library is fitted with a tool that allows the design of new receptor systems as well as the modification of the existing ones.

3.2.7 Help

This option provides the user with the instructions of the program, according to the windows standards.

3.3 Sewage

The Sewage application is executed by double clicking on the relevant icon. After a while, the following application main screen appears with the options “Files”, “Project data”, “View”, “Windows”, “Libraries” and “Help” which are described and illustrated below.

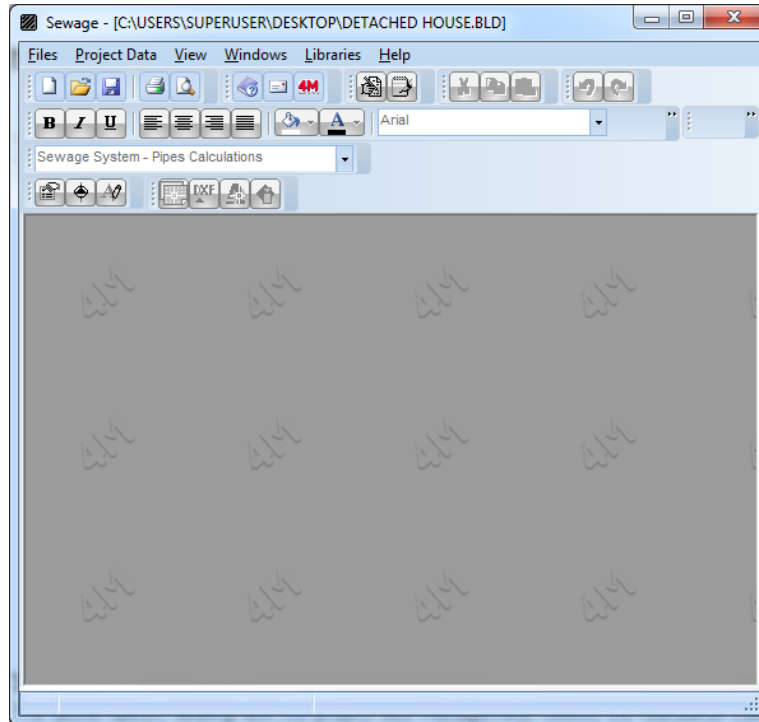

3.3.1 Files

The above option, dealing with the project files management, follows the standards that have been described above for the Water Supply application.

3.3.2 Project data

General data refer to titles and headings related to the project identity, while the “Network” options are described in detail below:

Water (Drain fluid) temperature: It is a parameter that is taken into consideration for special cases (such as industrial applications).

Type of building: According to the type that is selected, the relevant runoff coefficient is taken into account. With the key “F12” or by pressing the key in the field, the list of the alternative options appears, from which you can select the preferred option (just “highlight” the relevant word and press the “Select” key).

Network Options	
Water (Drain fluid) Temperature (°C)	10
Type of Building	Apartment, Restaurant, Hotel, Office
Coefficient of run-off (Vs)	0.5
Type of Main Pipes	Plastic
Pipes Roughness Factor	1000
Type of Secondary Pipe	PVC 6 atm
Secondary Pipe Roughness Factor (m)	1000
Main Desirable Slope (cm/m)	2
Horizontal Piping Degree of Admission	0.5
Ventilation Type	Main
Rainfall r (Vs ha)	300
Type of Run-off Areas connected to Gutter	Roof (Inclination > 15°)
Coefficient of rain water run-off q (0-1)	1.0
Import data from the Vertical Diagram	<input type="checkbox"/>



Coefficient of run-off: It depends on the building type, which means that it takes automatically the appropriate value, according to the user's selection, which can be certainly modified by the user, either here as a whole or within the calculation sheets, in a selective part of the network.

Type of main pipes: With the key <F11> or by pressing the key in the field, you can select from the pipe library window that appears, the pipe type that will be used in the project.

Pipes roughness factor: The above selected pipe roughness appears in (μm), which can be modified if you wish so.

Type of secondary pipe: With the key <F11> or by pressing the key in the field, you can select from the pipe library window that appears, the pipe type that should be used in the project.

Secondary pipe roughness factor: The above selected pipe roughness appears in (μm), which can be modified if you wish so.

Main desirable slope: A general value 2 cm/m is given, which can be modified by the designer within the calculation sheet, in each part of the network.

Horizontal piping degree of admission: The user selects a value with the key <F11> or by pressing the key in the field. The degree of admission can also be modified by the designer within the calculation sheet, in a selected part of the network.

Ventilation Type: In this field the user has the option of the main, the lateral and the secondary ventilation. In this case too, the ventilation type can be modified by the designer within the calculation sheet, in a selected part of the network.

Rainfall r: The rainfall value is filled in l/(s x ha).

Type of run-off areas connected to gutter: With the key <F11> or by pressing the key in the field the user selects from the window that opens, the appropriate building type:

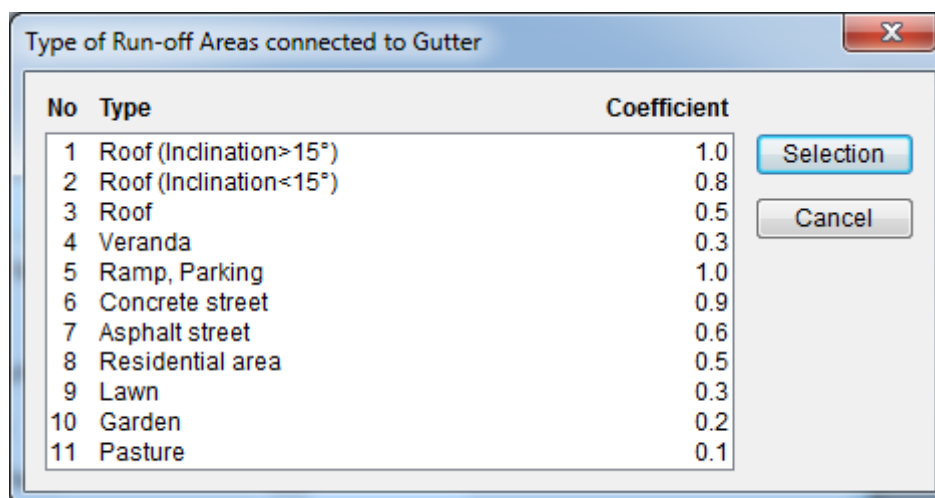

Coefficient of rain water run-off q (0-1): The coefficient Y, which represents the proportion of runoff quantity to rainfall, gets automatically its value according to the above selected surface type (see the table).

Import data from the vertical diagram: This option enables you, as in the Water Supply application, to draw the vertical diagram before fill in the calculation sheet with the aid of an expert system and thereafter transfer the data in the calculation sheet. If the check box is checked, the option “Draw vertical diagram” appears in the program menu and you can use it to draw the vertical diagram.

3.3.3 Import data from the Vertical Diagram

This option enables the “Draw vertical diagram” tab in which the “Vertical diagram creation” and the “Update from vertical diagram” options are included in accordance with the “Water Supply” corresponding options (see section 2.2.3). They are explained in the following sections.

3.3.3.1 Vertical Diagram Creation

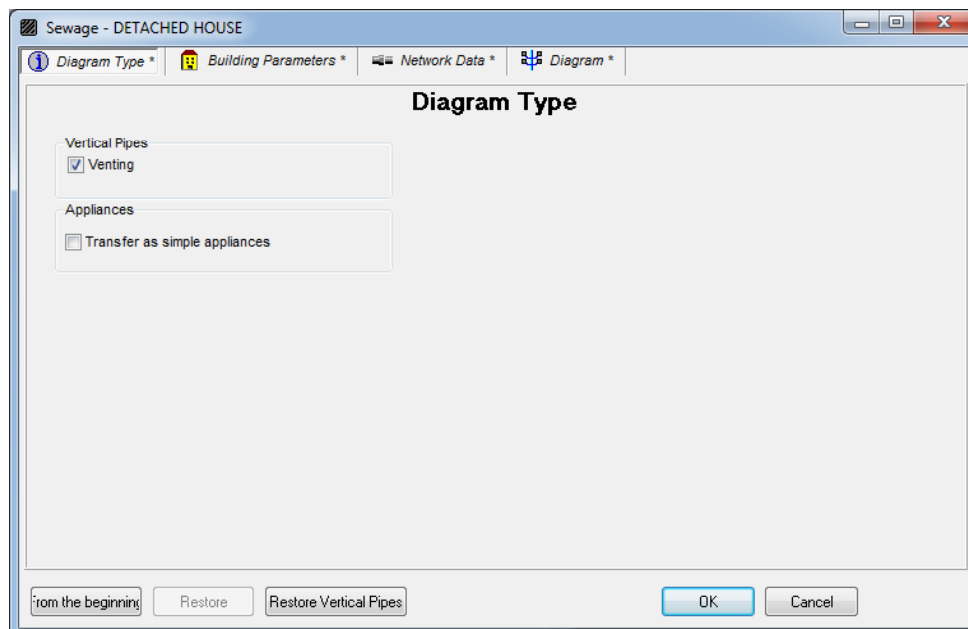

This option has the following secondary options:

1. Diagram Type

Here you can specify the general topology of the chart that you are going to draw.

- **Vertical pipes > Venting**

It is specified whether the vertical columns will appear in the vertical chart with or without ventilation.

- **Appliances > Transfer as simple appliances**

It is specified whether each receptor is defined separately in the vertical chart or if it will be integrated in a receptor group. In case that the check box is checked, the network is analysed thoroughly in nodes.

2. Building parameters

The topology of the building, as well as the layout of the installation network in it are included in the building data. There are two distinct secondary options:

A. Building definition

Here the levels (floors) which constitute the building, are defined. In particular, if you select the Basement and the Floors, an additional field will appear where the user should fill in their number. You can also define the number of the apartments in each floor as well as the height of each floor.

After the user has defined the building data, he can press the key “Application” and the building will appear in the left column in a tree form with an icon in front of it that shows the floor type.

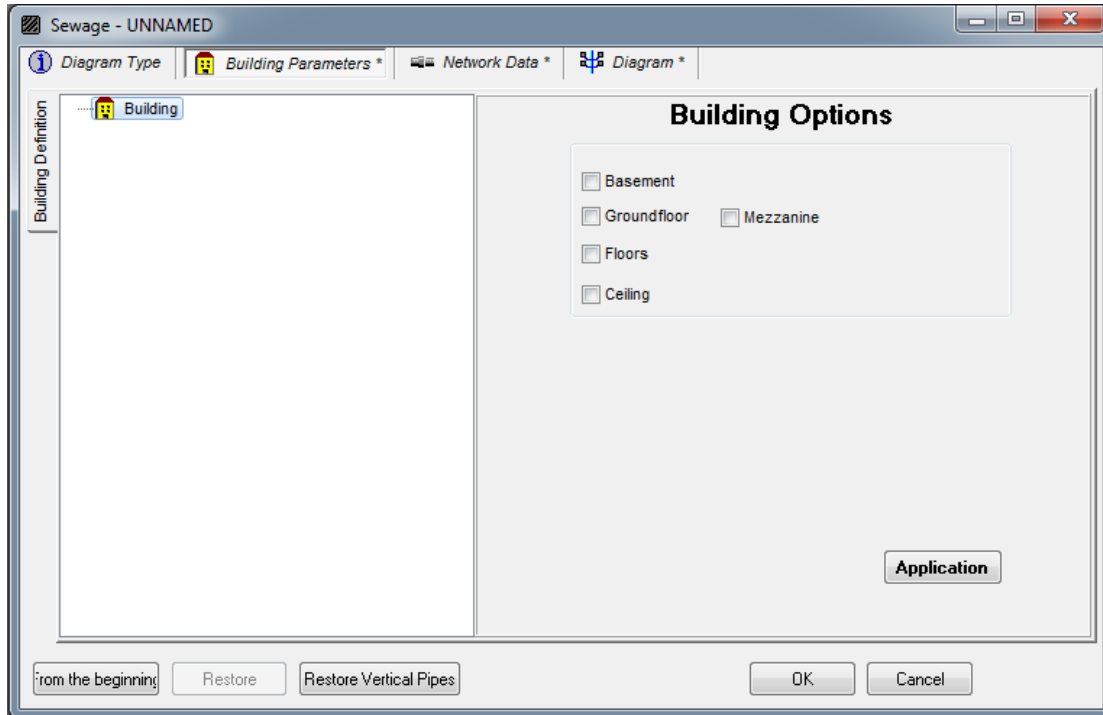

Working with levels

If you click with the left mouse key on the level name, the level data “Level Name”, “Level Height (m)” and “Number of Apartments” appear on the right side. The user can enter the fields “Level Name” and “Level Height (m)” and edit the level data.

If you double click with the left mouse key on the level name, the floor topology with the apartments will appear in tree form.

If you click with the right mouse key on the floor name, a menu with the following options will appear:

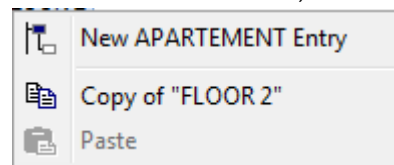

- **New Apartment entry:** You can insert a new apartment besides the ones that are defined so far.
- **Copy of FLOOR:** Copies in the PC memory (clipboard) the floor network in order to paste (copy) it later on a different floor.
- **Paste FLOOR:** You can copy the network data that are saved at the clipboard into the selected floor. The data that are already entered in the floor shall be overwritten by the new data.

Working with apartments

If you double click on the floor the apartments will appear and in the right side the option "Insert space with discharge point" will appear, where a list with various space types will be shown. If you double click on a space, its drawing will appear underneath it. If you double click on the desired space, this will be transferred automatically in the apartment selected in the left column. In the same way you can add more spaces in the same apartment or in different ones.

If you right click on a room, the list shown in the next window will appear, with which you can manage the rooms:

- The command "Insert", inserts a new space.
- The command "Delete", deletes a space.
- The command "Copy", makes a copy of this space

3. Network data

In the option you can set the network structure from the receptors up to the sewage runoff towards the city network or the sewage pit.

In this option the user can manage the sewage runoff. At first, each apartment is connected to the above one (IS1-D1 to OP1-D1, IS2-D1 to OP2-D1 etc.).

But if the vertical sewage columns position is different, then the user can transfer the runoff from a column to a different one and delete a column or a runoff end point.

This is achieved by right clicking on an element. Depending on the tree element on the left side of the window that you right click, a menu appears that enables you to move or delete or even add an element.

Hence, you are able to modify the network as it is desired.

4. Diagram

With this option, the vertical diagram of the previously mentioned installation appears. The user can change the colors that appear in the chart and disable several network information.

Apart from that, with the option *Drawing Distances* he can define the distances between the lines in order to acquire a better view of the diagram.

3.3.3.2 Update from a vertical diagram

This command is used to transfer the network data of the vertical diagram in the "Calculation sheet".

3.3.4 View

This option includes the secondary option "Toolbars" and follows in general the windows standards.

3.3.5 Windows

The "Windows" option includes a series of calculation and result windows, in which the detailed project calculations are presented. The main window which comprises the core of the application calculations is the Calculation Sheet, and it is described in the following paragraphs.

3.3.5.1 Cover Page

The "Cover page" window is the first printed page of the project and the program enables the user to select among different types of cover pages, or even create his own cover page, exactly as he wants it.



Note: The cover page files are stored in FINE11_SANI\CALC\ApoX, named APOXCV01.RTF; the description is stored in the file APOXCV.LST.

3.3.5.2 Assumptions

The text of the project general assumptions, which may be included in the printed project as long as it is selected in "Printing Contents", is stated. If the option "Assumptions" is selected, the option "Assumptions" with the secondary option "Select Prototype" appear in the menu.

3.3.5.3 System of appliances

Here the appliances systems that are used in the specific project are presented and analysed in the receptors constituting them.

3.3.5.4 Label of appliances

Here the label of appliances systems that are used in the specific project are presented and analysed

3.3.5.5 Calculation Sheet

The Sewage Network Calculation Sheet constitutes the calculations core of the Sewage application and follows the general rules of Network Calculations Sheet described in Chapter 1. Each row of this sheet corresponds to a different part of the Sewage network, while each column refers to the data that will be filled in or will result automatically during the completion process.

Instructions for the completion of these data appear at the bottom of the window (status bar). First of all, in each row you should fill in the first column that refers to the symbolism of a certain sector.

The network standardisation way is based on the standardisation rules that are explained in the first section, which will be repeated in the following sections with a particular Sewage network example, after explaining the calculations sheet columns:

1. Network Section: In the first column rows you can fill in one-by-one all the network sections (one section for each row). You can determine each section by giving two nodes with a dot between them. You can determine each node by one number (from 1 to 9999) or by one letter (upper or lower case) or by a combination of letters and numbers (such as A2, AB, 3g, Aa etc). The basic numbering limitation is that the point connected to the city network is always represented by "1", while the same number cannot appear twice in the same network (except number "1" which can be used more than one time).

Network Section	Pipe Length (m)	Type of Pipe	Degree of Admission	Type of Ventilation	Type of Appliance	Supply value SAWs	Peak runoff (l/s)	Desired Slope (cm/m)	Desired Pipe Size (mm)	Pipe Size (mm)	Sewage velocity (m/s)	Immersion of network	Sewage Runoff Coefficient	Polar Angle
1	1.2	0.8 Rain Water Hor.Pipe	0.7				0.178	1		DN70	0.559	0.008	0.5	
2	2.3	3.0 Rain Water Ver.Pipe					0.178			DN70			0.5	
3	3.4	1.5 Rain Water Hor.Pipe	0.7		16		0.178	1		DN70	0.559	0.015	0.5	
4	1.5	5.0 Vertical	0.5	Main		5.000	1.118	2		DN100	1.008	0.100	0.5	
5	5.6	3.0 Vertical		Main		5.000	1.118			DN100			0.5	
6	6.7	3.2 Vertical	0.5			2.500	0.791	2		DN70	0.790	0.064	0.5	
7	7.8	1.2 Vertical	0.5		4	0.500	0.354	2		DN40	0.534	0.024	0.5	
8	7.9	2.0 Vertical	0.5		5	1.000	0.500	2		DN50	0.625	0.040	0.5	
9	7.10	0.1 Vertical	0.5		12	1.000	0.500	2		DN50	0.625	0.002	0.5	
10	6.11	2.0 Vertical	0.5		10	2.500	0.791	2		DN100	1.008	0.040	0.5	
11	1.12	0.4 Rain Water Hor.Pipe	0.7				0.178	1		DN70	0.559	0.004	0.5	
12	12.13	3.0 Rain Water Ver.Pipe					0.178			DN70			0.5	
13	13.14	1.5 Rain Water Hor.Pipe	0.7		16		0.178	1		DN70	0.559	0.015	0.5	
14														

After numbering, you can add to the project calculations sheet all the sections separately one-by-one (without paying attention to the section sequence), filling in the two nodes of each section to the first column (with a dot between them) against the sewage flow into the pipe section. Keep in mind, that in case of typical (similar) sections, you can recall them (using their name from the first column) and they will be transferred automatically.

2. Pipe Length: The user has to determine the pipe length in (m) in every section between two nodes (e.g. section 2.3) in case he hasn't started the project from FINE SANI.

3. Type of pipe: You can fill in one of the following indications, depending on the pipe type:

- If you have an horizontal sewage or mixed sewage pipe you don't have to fill in anything (it remains blank).
- If you have a vertical sewage or mixed sewage pipe, you select "Vertical".
- If you have an horizontal rainwater pipe, you select ""Rain water horizontal Pipe".
- If you have a vertical rainwater pipe, you select "Rain water vertical pipe".

The content of the columns 4, 5 and 9 depend on the Pipe type you are going to fill in. To be more specific, columns 4 (Degree of admission) and 9 (Desired slope) correspond to the horizontal pipes, while column 5 (Ventilation Type) corresponds to the vertical ones.

4. Degree of admission: Since the pipe is horizontal (the content of column 3 is blank), this column content will be updated by the output ratio value specified in "Network Data".

Since you have entered in column 3 the indication "Rain water horizontal pipe", the degree of admission in column 4 will turn automatically to 0.7 (see output table in "Network Data"). The user can interfere and modify the value for each network section in an appropriate way and in accordance with the above mentioned table.

No	Name	In.Dia.	AWs	Jumbé
1	Kitchen sink	46	1	
2	Washing mach	46	1	
3	Dish-washer	46	1	
4	Wash basin	36	0.5	
5	Bath - connecti	46	1	
6	Bath - connecti	69	1	

5. Type of ventilation: If the pipe is vertical, you must fill in the ventilation type of the corresponding section. The possible options are the following: main, lateral and secondary ventilation. Needless to say that after you fill in the first column, the ventilation type specified in "Network" is filled in automatically.

6. Type of appliances: If the specific network section ends to a receptor, you can select tie type of the receptor from the Sewage receptors library, after you click F11 or press the key in the field in this column. Then a window will appear with the receptors list.

In this window, after you find the receptor you want, you will fill in the last column the number you want (e.g. if in the same network section two wash basins are connected, then in this window, in the line of the wash basin you will set the number "2" in the last column). By clicking "OK" you can return to the calculations sheet in column 6 where you can notice that the receptor order number that you had specified is filled in. Instead of specifying only one receptor you can, alternately, specify a group of receptors (Receptors System) up to 10 in total, different receptors types for every section. Since you work with receptors groups, the programme gives you the possibility to specify a hydraulic receptors system order number i at the upper part, so the corresponding receptors system appears in the sixth column of the Calculations sheet under the Form S- i , where i is the specified System order number. Thanks to this feature you avoid filling in again the same hydraulic receptors, since you can fill in directly the System order number in the receptors column 6. This working mode with receptors systems is indicated in cases of large installations, where you can drastically reduce the data volume in the calculations sheet.

7. Supply Value SAWs: Since you have selected a receptor from the library, as shown earlier, the total connection values SAWs is filled in automatically. You can also fill in directly the supply value, as long as you want to avoid specifying the receptors. In case of rainwater this column represents the rainwater runoff.

8. Peak Runoff (l/s): It results automatically according to the following equation:

$Q_s = K \text{ SAWs}$ where K is the runoff coefficient (in l/s) and SAWs is the sum of the connection values.

9. Desired slope: Initially, the default inclination value in the "Network" is filled in this column (which refers to horizontal pipes); a value that you can certainly modify.

10. Desired pipe size: You can select through this column a diameter (by clicking the key in the field) different from the one estimated by the program (and appears in the next column) as well as check the effect of your option to the other network parameters (e.g. sewage velocity). By clicking you can delete the desired diameter and cancel the program option, which means that the program will calculate again the diameter.

11. Pipe size: This column represents the network section pipe diameter, as it was calculated by the program.

12. Sewage velocity: The sewage velocity value appears (m/s), according to the program calculations.

13. Immersion of network: The sewage immersion of the network appears (m/s), according to the program calculations.

The elements "Polar Angle", "Well", "Cleaning pug" "Multiplier", "Pipe type", "Type of connected run-off area", "Rainwater runoff coefficient", "Rainfall surface", "Peak rain water runoff" and "Pipe design Length" come afterwards. These data can be directly filled in the corresponding columns or even through an additional window that appears when you click F12 or select "Additional Data" from the list, which appears when you press the right mouse key in the corresponding row.

The utility of these data is described below, according to the order in which they are listed:

14. Polar Angle: You have to fill in the polar angle only if you want to get a vertical diagram (and sketch) from the calculations sheet and not from FINE SANI where it is produced automatically. The constructed vertical diagram, takes into account the length and the polar angle (with regard to the horizontal axis) of each sector. At the beginning, the polar angle value is zero for all the network sections.

15. Well and cleaning plug: If you want to draw a well or a cleaning plug you have to fill in the corresponding information so that it gets placed upon the vertical diagram. This work isn't needed if you have drawn the plan views from FINE SANI, which means that the vertical diagram will be produced automatically.

16. Multiplier: Especially for the network sections that are situated between a node and an hydraulic receptor you can also fill in (optionally) a multiplier (values between 0-1) for the calculation, apart from the runoff coefficient.

17. Pipe Type: You have to fill in whether each network pipe is the main or the secondary one (these types have been defined in "Network" options). You can, thereby, determine two different pipe types (materials) in the network.

18. Type of connected run-off area: In this column you determine the surface type connected to the gutter that is declared as a receptor. Keep in mind that the surface type automatically designates the rainwater runoff coefficient.

19. Rainwater Runoff Coefficient: As it was also mentioned at the "Network" options, it depends on the connected surface and gets a value from 0 to 1.

20. Rainfall surface: You determine the surface area (in m²) connected to the specific gutter, which is declared as receptor.

21. Peak rain water run-off: As it was also mentioned at the "Network" this coefficient depends on the building type.

If you follow the above standardisation concerning the network sections, you can automatically calculate the runoffs, even in the intermediate sections (where there are no receptors), which will appear in every network section. You can define the cross-section in the section pipe, which appears in column 10, in accordance with the peak runoff in every network section. The designer can though, if he wishes so, designate a different standardised diameter, by pressing <F11> or the key in the field in column 9 and by selecting one of the standardised diameters that appear on the screen.

You can calculate a) the real sewage velocity and b) the network immersion in the horizontal sections where they will also appear.

You can understand more easily the whole standardisation through the following example.

22. Pipe drawing length (m): In the vertical diagram drawing, many times have been drawn too short or too long sections. In order to be able to see and control more easily the vertical diagram, you can determine in this column an arbitrary length, which will give to your drawing the desired **aesthetic** effect. Regardless of the length that you will determine in this field, the program will write on the drawing the **real pipe length**. It should be pointed out, that if you leave this field blank, the program will draw the vertical diagram according to the "Calculations Sheet" second column, "Pipe Length".

Moreover, if you select the "Fixed Column" through the "Calculation Sheet" menu, it "freezes" the first sheet column in your screen. Consequently, as you fill in the fields in the sheet and you are "driven" more rightwards, you know, at any time, the exact network section in which you are working. When the "Fixed Column" is activated, a yellow point (pin) appears at the lower part of the "frozen" field.

Example (this example is in case that the user hasn't designed the network in FINE SANI): Lets suppose that you have the Sewage network that is shown in the following figure:

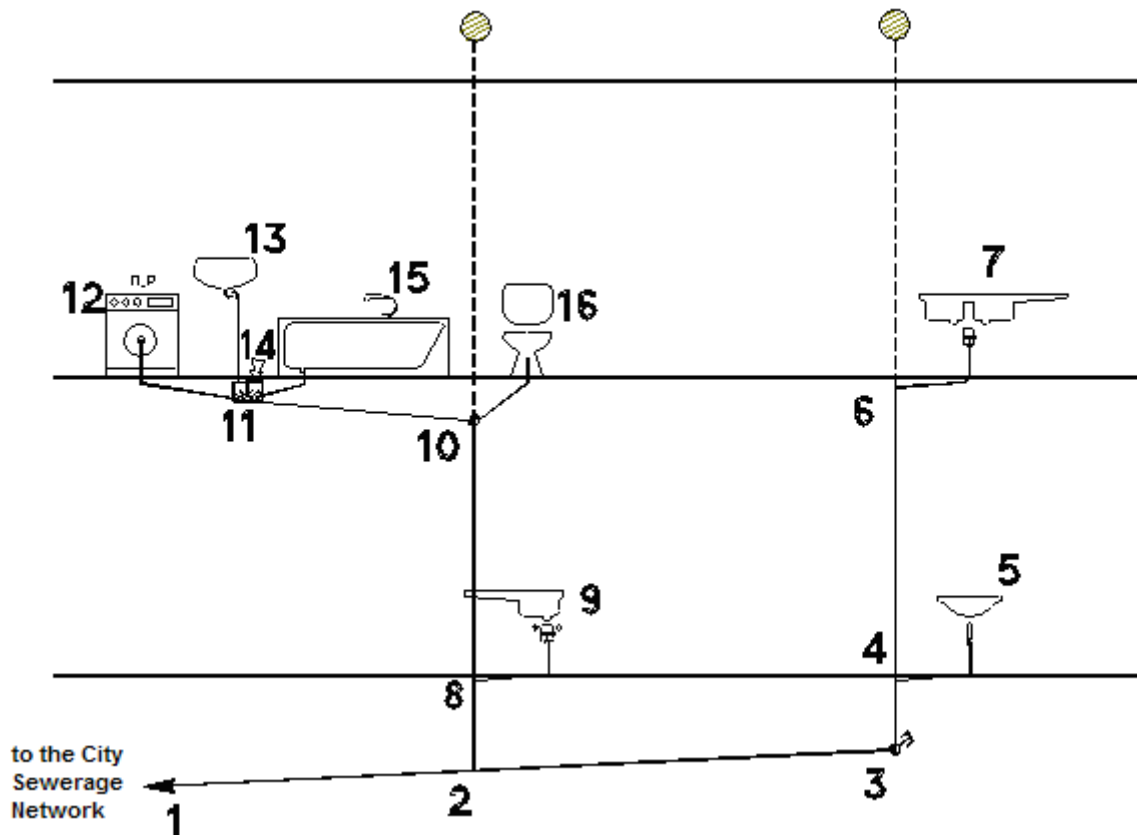

The first step you have to take for the network calculation is to number the nodes and receptors, starting from “1” for the central runoff point (towards the city network) and applying the numbering as it is represented in the figure.: It is pointed out that the number 11 is assigned to the node towards which the Sewage pipes of the three receptors head and the drain trap (number 14).

Following the general standardisation described in chapter 2, you can fill in one-by-one in the calculation sheet the network sections with their lengths, the indication “Vertical” for the vertical sections and the receptor type (in the sections where there are receptors). In this way you end up at the following calculations sheet:

Network Section	Pipe Length (m)	Type of Pipe	Degree of Admission	Type of Ventilation	Type of Appliance	Supply value SAWs	Peak runoff (l/s)	Desired Slope (cm/m)	Desired Pipe Size (mm)	Pipe Size (mm)	Sewage velocity (m/s)	Immersion (m)	Sewage Runoff Coefficient	Polar Angle	Well	Cleaning plug	Multiplier	Pipe Type	Type c	
1	1.2	4	0.5			7.500	1.369	2		DN100	1.008	0.080	0.5					Main		
2	2.8	1		Vertical	Main	6.500	1.275			DN100			0.5	90				Main		
3	8.9	2.5	0.5		4	0.500	0.354	2		DN40	0.534	0.050	0.5					Main		
4	8.10	3		Vertical	Main	6.000	1.225			DN100			0.5	90				Main		
5	10.11	2		Vertical	Main	3.500	0.935			DN70			0.5	90				Main		
6	11.12	1.2	0.5		2	1.000	0.500	2		DN50	0.625	0.024	0.5					Main		
7	11.13	1.4	0.5		4	0.500	0.354	2		DN40	0.534	0.028	0.5					Main		
8	11.14	1.6	0.5		12	1.000	0.500	2		DN50	0.625	0.032	0.5					Main		
9	11.15	2.1	0.5		5	1.000	0.500	2		DN50	0.625	0.042	0.5					Main		
10	10.16	3	0.5		10	2.500	0.791	2		DN100	1.008	0.060	0.5					Main		
11																				
12	2.3	1	0.5			1.000	0.500	2		DN70	0.790	0.020	0.5					Main		
13	3.4	2		Vertical	Main	1.000	0.500			DN70			0.5	90				Main		
14	4.5	3	0.5		4	0.500	0.354	2		DN40	0.534	0.060	0.5					Main		
15	4.6	2		Vertical	Main	0.500	0.354			DN70			0.5	90				Main		
16	6.7	1.4	0.5		4	0.500	0.354	2		DN40	0.534	0.028	0.5					Main		
17																				
18																				
19																				
20																				
21																				
22																				
23																				
24																				
25																				

It is noticed that in section 11.14 you don't fill in a length value, as this section is required only to simply indicate the existence of a drain trap.

Since you also want to get a vertical diagram you should assign to each section a polar angle as follows:

- For each section 1.2 and 2.3=> $f=5$
- For the vertical sections 2.8, 8.10, 3.4, 4.6 and 11.13=> $f=90$
- For 10.11, $f=175$
- For 10.16 and 11.15, $f=30$
- For 11.12, $f=150$
- For 8.9, 4.5, 6.7 you can designate $f=30$ or for a better result you could determine a separate node for the angle and designate $f=5$ and $f=90$ for the two sections determined in such a way, respectively.

Keep in mind that if you have started the project from FINE SANI, the vertical diagram is automatically produced by the plan views, which means that there is no need to determine these angles.

3.3.5.6 Septic tank calculation

In this window the user can calculate and select the type of the septic tank.

3.3.5.7 Pit calculation

In the pit calculation window, as soon as the user gives several information, the program calculates the absorptive pit area fab.

3.3.5.8 Sewage lift station calculation

Depending on the type of the flow, the user selects the type of the lift station.

3.3.5.9 Sewage lift pump calculation

If there is a sewage lift pump calculation, in this window, the user selects its type.

3.3.5.10 Network drawing

The numbered network drawing is shown on the screen, provided that polar coordinates have been inserted in every network branch (see calculation sheet).

3.3.5.11 Vertical Diagram

If the user wants to create a vertical diagram using the calculation sheet (and not automatically, using FINE SANI), the above option creates the vertical diagram provided that the polar coordinates have been inserted in every network branch.

It is pointed out that it is possible to select a drawing for the engine room from the menu "Vertical diagram".

3.3.5.12 Bill of Materials - Costing

The bill of materials-cost estimation results regarding the specific project are presented. The user can edit the bill of materials sheet, modify costs or quantities, insert discounts, and add jobs or materials.

3.3.5.13 Technical Description

The window "Technical Description" supports the creation of the project technical description, enabling the user to select among various technical description prototypes and text editing styles.

3.3.5.14 Detailed bill of materials

In the "Detailed bill of materials" window the user can see the quantities of each material analytically and make his own additions.

3.3.6 Libraries

The Sewage libraries contain the following:

- **Pipes** with a given velocity, standardisation, (nominal, internal diameter) and costs.
- **Appliances (hydraulic receptors)** with all their characteristics (minimum connection diameter, connection value) and costs.
- **Systems of appliances:** This library enables you to create new receptors systems and edit the ones that already exist.
- **Offer libraries:** This library enables you to create your own offer libraries and use them in the project.

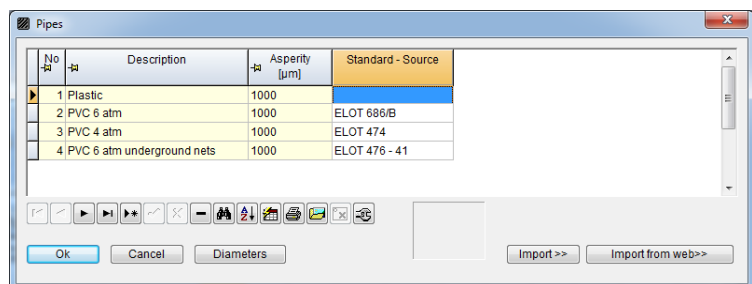

No	Description	Asperity (µm)	Standard - Source
1	Plastic	1000	
2	PVC 6 atm	1000	ELOT 686B
3	PVC 4 atm	1000	ELOT 474
4	PVC 6 atm underground nets	1000	ELOT 476 - 41

3.3.7 Help

This option provides the user with instructions for the program according to the windows standards.